

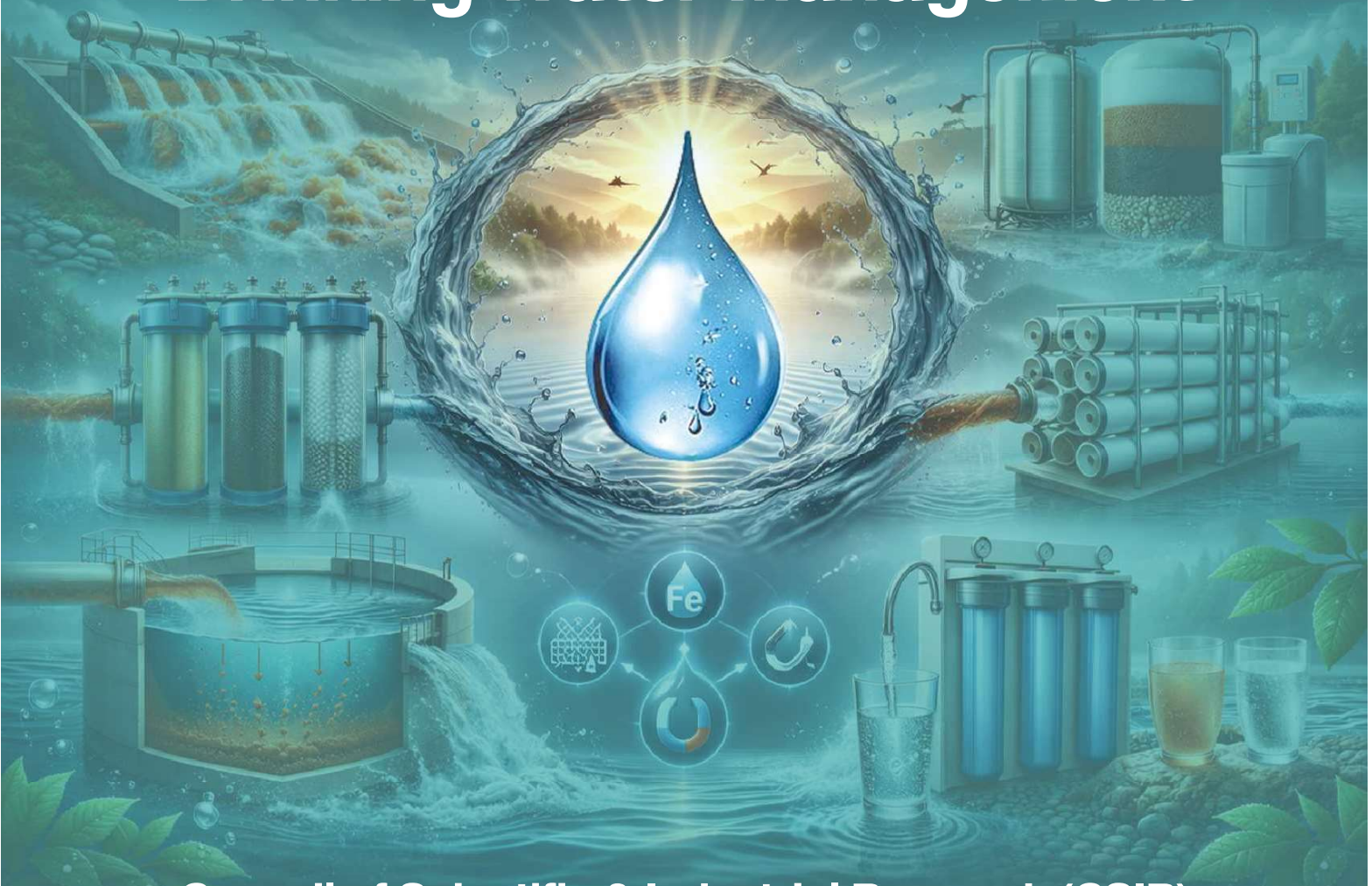

सीएसआईआर
CSIR
भारत का नवाचार इंजन
The Innovation Engine of India

Compendium of CSIR Technologies for Drinking Water Management



Council of Scientific & Industrial Research (CSIR)
New Delhi, India

April 2026



Compendium of CSIR Technologies for Drinking Water Management

**Council of Scientific & Industrial Research (CSIR)
New Delhi, India**

April 2026



Compendium of CSIR Technologies for Drinking Water Management

Prepared by

**CSIR-National Environmental Engineering Research
Institute (NEERI), Nagpur**

Published by

**Council of Scientific & Industrial Research (CSIR)
New Delhi, India**



Contact: Director General, CSIR, Rafi Marg, New Delhi India

Tel: +91 11 23710472, 23717053 Fax: +91 11 23710618

Email: dg@csir.res.in; dgsir@csir.res.in

Editorial & Advisory

Dr. S. Venkata Mohan

Director, CSIR-NEERI



Compiled by

Dr. Atul Maldhure

Scientist E, CSIR-NEERI

Dr. Paras R. Pujari

Scientist G, CSIR-NEERI



Secretarial Assistance

Ms. Vandana Sanjay Cinthray

Private Secretary



सत्यमेव जयते

डॉ. (श्रीमती) एन. कलैसेल्वी
सचिव, वैज्ञानिक और औद्योगिक अनुसंधान विभाग
महानिदेशक, वैज्ञानिक तथा औद्योगिक अनुसंधान परिषद्

Dr. (Mrs.) N. Kalaiselvi
Secretary, DSIR and Director General, CSIR



भारत सरकार

विज्ञान एवं प्रौद्योगिकी मंत्रालय
वैज्ञानिक और औद्योगिक अनुसंधान विभाग
वैज्ञानिक तथा औद्योगिक अनुसंधान परिषद्
Government of India
Ministry of Science and Technology
Department of Scientific & Industrial Research
Council of Scientific & Industrial Research

Foreword

Access to safe drinking water is fundamental to public health, human dignity, and national resilience. It is estimated that waterborne diseases have an economic burden of approximately USD 600 million a year in India. The primary contaminants in groundwater are arsenic, fluoride, nitrate, iron, and salinity. According to the 2024 report, 9.04% of drinking water sources were affected by fluoride, and 3.35% were contaminated with arsenic among the monitored groundwater sources. In providing safe water to everyone, field-deployable drinking water treatment technologies play a vital role in maintaining a safe water supply under such demanding conditions.

Council of Scientific and Industrial Research (CSIR), through its vast network of 37 laboratories and interdisciplinary expertise, has consistently focused on developing innovative, affordable, and scalable water treatment solutions tailored for field applications. These technologies are designed to address a broad spectrum of contaminants, including microbial pathogens, chemical pollutants, heavy metals, and suspended impurities, while ensuring portability, operational simplicity, energy efficiency, and robustness.

This Compendium on Field-Deployable Drinking Water Treatment Technologies brings together validated, ready-to-deploy solutions developed across CSIR laboratories and in collaboration with partner institutions. It serves as a practical reference for central and government water supply departments, government agencies, implementing agencies, and other stakeholders engaged in providing safe drinking water in diverse, often unpredictable environments.

The compendium reflects CSIR's commitment to translating scientific research into tangible societal benefits. By promoting indigenous, context-appropriate technologies, we aim to strengthen national preparedness, enhance water security, and improve public health outcomes. I appreciate the dedicated efforts of the scientists, engineers, and collaborating organizations whose contributions have made this compilation possible. I am confident that this document will facilitate informed decision-making and encourage wider adoption of reliable field-deployable water treatment systems across the country.

April 4, 2026
New Delhi

(N. Kalaiselvi)

Dr. S. Venkata Mohan

Director

CSIR-National Environmental Engineering Research

Institute (NEERI)

Nagpur

PREFACE

Drinking water quality is a critical environmental determinant of public health, directly influencing human well-being, economic productivity, and national resilience. Ensuring continuous improvement and sustained assurance of safe drinking water remains essential for preventing and controlling water-related health issues. Recent nationwide assessments by State water supply agencies indicate a growing number of sources affected by both geogenic and anthropogenic contamination.

The Council of Scientific and Industrial Research (CSIR), through its network of national laboratories, have consistently contributed to addressing these challenges by developing innovative, science-driven, and field-validated solutions for drinking water treatment. The technologies compiled in this volume are the outcome of sustained research, rigorous field evaluation, and collaborative efforts across institutions designed to address a wide spectrum of contaminants under diverse environmental and operational conditions. This compendium has been prepared as a practical reference for implementing agencies and other stakeholders involved in ensuring safe water supply in challenging, resource-constrained environments. It consolidates indigenous technologies that emphasise reliability, scalability, cost-effectiveness, portability, and operational simplicity, enabling their deployment across varied field scenarios.

I sincerely acknowledge the guidance and valuable advice of the Director General, CSIR, and express my gratitude to the Directors of CSIR laboratories for their support in compiling this compendium. I also place on record my appreciation for the dedicated efforts of Dr. Atul V. Maldhure, Scientist E, Water and Earth Systems, CSIR-NEERI and his team for compiling this compendium.







Dr. S. Venkata Mohan



List of CSIR Technologies for Drinking Water Management



CONTENTS









S.No.	Name of Technology	CSIR Lab	QR Code	Page No.
I.	Fluoride Removal Technologies			1-52
1.	Nano-adsorbent based user-friendly household filter for the purification of fluoride, arsenic and microbes contaminated water	CSIR-AMPRI		03
2.	Ceramic Membranes with positive surface charge for defluoridation of contaminated water for drinking purpose	CSIR-CGCRI		10
3.	Community Level Fluoride Removal Plant	CSIR-CMERI		13
4.	Domestic Fluoride Removal Unit (Domestic Water Filter for Defluoridation)	CSIR-CMERI		16
5.	High Flow Rate Fluoride & Iron Removal Plant	CSIR-CMERI		22
6.	Community/Domestic Level Fluoride, Arsenic & Iron Removal (FAIR) Technology	CSIR-CMERI		26
7.	Fast and safe defluoridation of water using alumina	CSIR-CSMCRI		30
8.	Solar Assisted Electrolytic Defluoridation (EDF) Technology	CSIR-NEERI		33
9.	Chemo-Defluoridation Process Unit	CSIR-NEERI		39
10.	Defluoridation – Nalgonda Technique	CSIR-NEERI		43
11.	In-situ treatment of fluoride in a hard rock setting by Managed Aquifer Recharge	CSIR-NEERI		49











S.No.	Name of Technology	CSIR Lab	QR Code	Page No.
-------	--------------------	----------	---------	----------

II. Arsenic Removal Technologies				53-82
12.	Ceramic Membrane based technology for removal of arsenic (including the process for media preparation) and iron from groundwater	CSIR-CGCRI		55
13.	Ceramic membrane based high capacity modules for: (A) pretreatment of turbid water for polishing of iron & arsenic contaminated water using micro filtration technique and (B) pretreatment of river water for turbidity and suspended particulate removal	CSIR-CGCRI		60
14.	High Flow Rate Arsenic Removal Filter	CSIR-CMERI		64
15.	Community level Arsenic Removal Plant (Model-I)	CSIR-CMERI		69
16.	Community Level Arsenic Removal Filter (Model II)	CSIR-CMERI		73
17.	Process based on polymer-based ion-exchange resins for the removal of arsenic from ground water and arsenic detecting kit	CSIR-CSMCRI		77
18.	Preparation of specific polymeric adsorbents for the removal of arsenic and arsenic & fluoride from drinking water	CSIR-CSMCRI		80

III. Iron Removal Technologies				83-106
19.	High Flow Rate Iron Removal Filter	CSIR-CMERI		85
20.	Domestic Iron Removal Filter	CSIR-CMERI		90
21.	Community Level Improved Iron Removal Plant (IIRP)	CSIR-CMERI		93

S.No.	Name of Technology	CSIR Lab	QR Code	Page No.
22.	Hand Pump Attachable Iron Removal Plant	CSIR-NEERI		97
23.	Household Iron Removal Unit	CSIR-NEERI		102

IV.	Turbidity / Microbial / Pathogen Removal Technologies			107-152
24.	Flat sheet ultra-filtration (UF) membrane and spiral module making technology for water purification and removal of pathogens	CSIR-CSMCRI		109
25.	Hollow fiber ultra-filtration membranes for water purification and removal of pathogens	CSIR-CSMCRI		112
26.	Hollow fibre domestic water filter of 1 LPM capacity operated under gravity without any electrical energy	CSIR-CSMCRI		115
27.	Atmospheric water generator with Remineralization	CSIR-IICT		118
28.	Oneer™: A novel solution for safe drinking water	CSIR-IICT		122
29.	TERAFIL Water Purification Technology for treatment of Iron & Turbidity from drinking water	CSIR-IMMT		125
30.	Safe Water and Sustainable Technology Initiative using Indian Knowledgebase (SWASTIHK)	CSIR-NCL		134
31.	“NEERI-ZAR” – Portable Instant Water Filter	CSIR-NEERI		141
32.	Slow Sand Filtration Technology	CSIR-NEERI		148

S.No.	Name of Technology	CSIR Lab	QR Code	Page No.
V.	Reverse Osmosis and Desalination Technologies			153-188
33.	Flat sheet thin film composite (TFC) reverse osmosis membrane and spiral module making technology for brackish & seawater desalination including bio-degradation of organic effluent stream generated in the membrane process development	CSIR-CSMCRI		155
34.	Nano filtration membrane for water softening by partial desalination, decontamination and disinfection	CSIR-CSMCRI		158
35.	Rejuvenation of the end-of-life seawater reverse osmosis membrane elements	CSIR-CSMCRI		161
36.	A high recovery ED-RO hybrid process for water purification/desalination with high water recovery	CSIR-CSMCRI		164
37.	Electro-dialytic desalination for production of mineral-balanced potable water	CSIR-CSMCRI		167
38.	Electro-deionization unit for producing ultrapure water	CSIR-CSMCRI		170
39.	Self-powered mobile van for water purification/desalination to provide safe potable water	CSIR-CSMCRI		173
40.	Compact and affordable hand pump ultrafiltration systems for surface & flood water purification	CSIR-IICT		176
41.	Compact and low-cost modular RO/NF systems for defluoridation of ground water and purification of surface water	CSIR-IICT		180
42.	Ultrafiltration driven Reverse Osmosis system for Mineral Enriched Drinking Water	CSIR-IICT		184

S.No.	Name of Technology	CSIR Lab	QR Code	Page No.
VI. Water Quality Testing Kit				189-202
43.	Portable Water analysis kit	CSIR-IITR		191
44.	Arsenic Estimation Field Kit	CSIR-NEERI		194
45.	Multi-Parameter Water Quality Measurement Field Test Kit	CSIR-NEERI		198
VII. IoT Enabled Water Service Delivery and Monitoring				203-249
46.	Fluoride Sensing System (FSS)	CSIR-CSIO		205
47.	On-line Nitrate Sensing System (ONSS)	CSIR-CSIO		212
48.	Turbidity Sensing System (TSS)	CSIR-CSIO		218
49.	Jal-IoT	CSIR-CSIO		225
50.	GIS-Based Dashboard for Affordable IoT-Enabled Water Service Delivery Measurement and Monitoring (IoT Dashboard 1.0)	CSIR-NEERI		234
51.	‘Jalabhilekh’: A Mobile Application for Identification, Geotagging, and Water Body Change Detection	CSIR-NEERI		238
52.	PipeSelect 1.0: A tool for Selection of Pipe Material for Water Supply and Sewerage Systems	CSIR-NEERI		242
53.	RISK-PiNET 2.0: Software for Water Distribution System Management	CSIR-NEERI		246
Deployed CSIR Technologies for Drinking Water Management				250
Ready to Deploy CSIR Technologies for Drinking Water Management				254

Introduction

Safe and reliable access to drinking water is fundamental to public health, economic development, and social well-being. Despite considerable advancements in water supply infrastructure, challenges related to water quality, resource depletion, contamination, and climate variability continue to affect millions of people. Groundwater sources in many regions are affected by geogenic contaminants, including fluoride, arsenic, and iron, as well as salinity. In contrast, surface waters are increasingly affected by microbial pollution, industrial effluents, agricultural runoff, and emerging contaminants. In disaster-prone, water-stressed areas, the need for rapid, decentralised, and resilient water treatment solutions becomes even more critical.

The Council of Scientific and Industrial Research (CSIR), through its network of 37 national laboratories, has consistently contributed to addressing these water quality challenges by developing innovative, science-driven, and application-oriented technologies. Over the years, CSIR has built strong expertise across membrane science, materials engineering, adsorption processes, electrochemical systems, advanced oxidation, and integrated treatment solutions. A key focus has been on translating laboratory research into deployable technologies that operate effectively in real-world conditions.

This compendium presents a consolidated portfolio of CSIR technologies related to Drinking Water Management that have been deployed in the field, reached advanced stages of development, and are available for field implementation, technology transfer, and commercialisation. “Ready-deployable” signifies that these technologies have progressed beyond proof-of-concept and have undergone pilot validation, field demonstration, performance optimization, and, where applicable, compliance assessment with drinking water standards. Most of these technologies have already been implemented in the field and are producing safe water under field conditions. They are designed for rapid installation, operational simplicity, cost-effectiveness, and adaptability to diverse water quality conditions.

The technologies featured in this compendium address a broad spectrum of contaminants and operational contexts, including:

- Removal of geogenic contaminants like fluoride, arsenic, iron, nitrate, and heavy metals
- Desalination of brackish and saline water

- Microbial disinfection and pathogen control
- Treatment of surface water with high turbidity and organic load
- Portable and emergency water purification systems
- Community-scale and decentralized modular treatment units

Emphasis has been placed on sustainability, energy efficiency, and affordability. Many systems incorporate low-energy designs, compatibility with renewable energy, minimal chemical use, and locally available materials. Modular configurations enable scalability from household-level units to village and community-scale plants, ensuring flexibility in response to demand and resource availability.

Importantly, CSIR's approach integrates scientific rigour with societal relevance. Each technology documented herein reflects a structured pathway from research and prototype development to field validation and industry engagement. This translational framework ensures reliability, operational robustness, and readiness for adoption by government agencies, rural development departments, disaster response authorities, public utilities, industry partners, and non-governmental organizations.

By providing scientifically validated, field tested solutions, CSIR contributes to national priorities in water security, public health, and sustainable development. The technologies presented in this compendium align with broader missions to achieve universal access to safe drinking water and strengthen resilience against climate induced water stress.

This compendium serves as both a technical reference and a deployment guide, facilitating informed decision-making and accelerating implementation. It reflects CSIR's commitment to leveraging science and innovation to deliver practical, scalable, and sustainable solutions that bridge the gap between laboratory research and societal impact.

Through these technologies, CSIR continues to advance the vision of ensuring safe, affordable, and accessible drinking water for all.

SECTION I

**FLUORIDE REMOVAL
TECHNOLOGIES**



**NANO-ADSORBENT BASED USER-FRIENDLY
HOUSEHOLD FILTER FOR THE PURIFICATION OF
FLUORIDE, ARSENIC AND MICROBES
CONTAMINATED WATER**

(Smart, Safe and Simple Solution for Clean Drinking Water)

TRL 6



CSIR-Advanced Materials and Processes Research Institute
(CSIR-AMPRI), Hoshangabad Road, Bhopal - 462 026
Madhya Pradesh, India

1. **Name of CSIR Laboratory :**
CSIR-Advanced Materials and Processes Research Institute, Bhopal
2. **Name of Technology :**
Nanoadsorbent based user-friendly household filter for the purification of fluoride, arsenic and microbes contaminated water
3. **TRL Level : 6 (Six)**



4. Preamble

Drinking water is a major source of fluoride and arsenic contamination that causes severe health problems. World health organization (WHO) has set the guidelines of 1.5 mg/l fluoride and 10 $\mu\text{g/l}$ arsenic as their permissible limit in potable water. Though, fluoride is beneficial in prevention of cavities formation in the teeth and provides strength to skeleton system but drinking of excessive fluoride contaminated water start dental and skeleton fluorosis problem, whereas, arsenic is entirely a toxic element for human being. In India only, more than seventy million people in nineteen states are suffering from fluorosis problem. Besides India, this problem is also common in countries like USA, China, Japan, Argentina, African and Gulf countries. As per report published in 2002, more than 23 nations have problem of excess fluoride in water.

Fluoride removal based on adsorption process comprises of separation of fluoride ions by adsorption on the alumina surface. Activated alumina which presents in its gamma phase possess more surface area and thus more effective for the removal of fluoride or arsenic or other inorganic toxic element from the water as compared to other known adsorbents. After saturation with these contaminants fluoride ions, it can be regenerated using low cost nontoxic chemicals like NaOH, H₂SO₄ and HCl. Further, reports by USEPA, 2003 suggest that activated alumina is the best material to reduce fluoride level below 1.5 mg/l (ppm), because it has got good affinity and selectivity for fluoride.

Challenges with existing activated alumina :

The use of large quantity of activated alumina in the column requires a lot of times in regeneration, choking of the column, are the main draw backs for the use of activated alumina for arsenic and fluoride removal of water. Because bigger particle size (0.4-1.2 mm), the adsorbent capacity of activated alumina for fluoride occurs very low (~2-4 mg/g).

Nanoalumina as adsorbent :

Smaller particle size of alumina can increase the surface area and additionally it will have better mass transfer efficiency. It has been observed that nanoparticles of gamma alumina show better efficiency than activated alumina particles present in micrometer sizes. Since nanoparticles have proven themselves as excellent adsorbents due to their unique features like high catalytic potential and reactivity, large surface area etc, its small quantity could be sufficient for the treatment of fluoride or arsenic contaminated drinking water in a large volume.

About Nanoalumina based technology :

The present technology involves the development of gamma nanoalumina particles a well-known adsorbent by low cost process and a simple methodology of incorporation of the developed nanoadsorbent in the conventional sediment removal water filter/cartridges. More particularly, the present technology relates to a method of synthesis of low cost nanoparticle of gamma alumina, a well-known adsorbent for fluoride and arsenic removal and their use in making of gravity operated household device useful for the treatment of up to 250 $\mu\text{g/l}$ (ppb) arsenic and 10 mg/l (ppm) fluoride present in contaminated drinking water. Besides arsenic and fluoride removal, the developed device can also be used for the purification of heavy metals like chromium, lead, cadmium etc. contaminated water. Developed filtration technology is also very effective for maximum removal of bacteria, viruses etc.

5. Technical Description

Present technology relates to development of a methodology of incorporating nanoparticles of well known gamma alumina adsorbent developed by a cost effective method, in conventional sediment removal water cartridges made of polypropylene sheet (porosity 10-20 micron make cylindrical cartridges / filter: 7 inch length, 1-2.5 inch dia). 130-150 g synthesized low cost (~ 10 USD/kg) nanoparticles of gamma (γ) alumina of 20-30 mg/g fluoride adsorption capacity and 25-30 mg/g arsenic adsorption capacity, was incorporated successfully in the sediment removal cartridges/filter. Afterward, a simple household filtration device containing nanoalumina incorporated two or three cartridges arranged in series, overhead tank for keeping arsenic or fluoride contaminated water and treated water storage container was made. 6 The developed filtration device can filter water at 1-5 lit/h filtration rate without electricity. Present invention demonstrates a simple method of incorporation of nanoadsorbent in the conventional sediment removal filter and making of a household filtration device that can be used for treatment of arsenic or fluoride contaminated ground/drinking water. Two or three number of 130-150 g nanoalumina incorporated cartridges made filtration device can treat 50-100 $\mu\text{g/l}$ arsenic contaminated 4000-10000 liter water and

2-5 mg/l fluoride contaminated 3000-6000 liter drinking water after 2- 3 regenerations. Two or three number of cartridges (size 7 inch in length and 1-2.5 inch in dia) containing 130-150 g incorporated nanoalumina are kept in housing in series whose inlet is attached to the overhead tank containing contaminated water and outlet is connected in plastic container where treated water is stored. The treatment cost is estimated to occur around 0.15 - 0.25 USD/100 liters for 50-100 µg/l arsenic and 0.25 -0.50 USD/100 liters for 2-5 mg/l fluoride contaminated water.

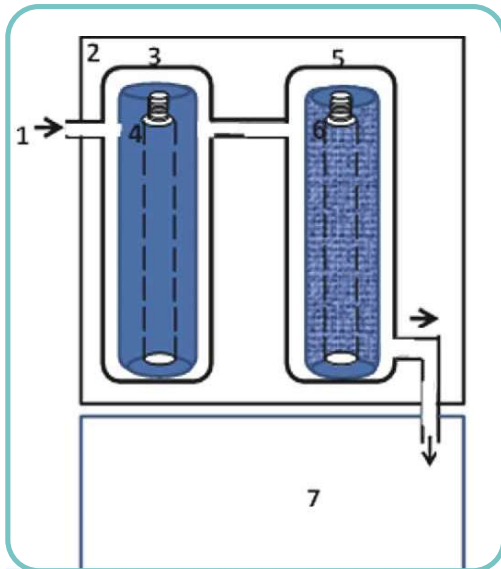

Fig. 1 The drawing of purifier operating for continuous treatment

- Component 1 :** Inlet of the contaminated water
Component 2 : Chamber 1 containing the filtration unit
Component 3 : Housing 1
Component 4 : Cartridge containing the hollow perforated tube wrapped with only polypropylene cloth
Component 5 : Housing 2
Component 6 : Cartridge containing the hollow perforated tube wrapped with only polypropylene cloth containing nanoalumina
Component 7 : Chamber 2 for storage of treated water

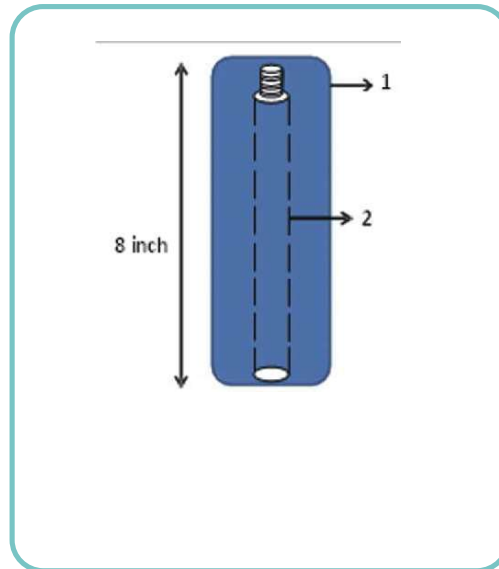

Fig. 2. Details of component 4 of Fig 1.

- Component 1 :** Polypropylene cloth wrapped around perforated hollow tube.
Component 2 : Perforated hollow tube.

5.1 Assembly of Unit/Installation Guide :

Synthesis of nanoalumina

The nanoalumina can be synthesised using precipitation method where the aluminium scrap was first dissolved in alkali to form sodium aluminate in solution form. The alkaline sodium aluminate solution was then neutralized with acid till precipitate is complete. The precipitates were filtered and washed thoroughly, annealed at optimized temperature for definite period of time.

Cartridge and Assembly of filters :

- Firstly, 240-250 g synthesized low cost nanoparticles of gamma (γ) alumina of 20-25 mg/g fluoride adsorption capacity for fluoride and 25-30 mg/g capacity for arsenic removal, was incorporated successfully in sediment removal filter make candle.

- Afterward, a simple household filtration device containing nanoparticles of nanoalumina incorporated candles, overhead tank for keeping arsenic or fluoride contaminated water and treated water storage container is made that can be operated at a 3-5 lit/h filtration rate without electricity.

This is a simple method of incorporation of nanoadsorbent in the conventional sediment removal filter candle and making of a household filtration device that can be used for treatment of arsenic or fluoride contaminated ground/drinking water applicable for small family living in remote arsenic or fluoride affected areas. Two numbers of 240-250 g nanoparticles incorporated candle make filtration device can treat 9000-1000 liter 90-100 ppb arsenic contaminated water and 4000-5000 liter 4-5 ppm fluoride contaminated drinking water after 3 regenerations.

6. Design Details

6.1 Salient Features

6.1.1 Novelty About Nanomedia as Adsorbent

- CSIR-AMPRI Nano H₂O care media is based on use of nanoalumina particles
- The developed nanomedia can be synthesized on bulk scale by a cost effective process
- Nanomedia has particle size 10-20 nm
- The developed media is insoluble in water
- Possess surface area of ~250 m²/gm
- High fluoride and arsenic removal capacity
- No Al leaching
- Can be regenerated for 2-3 times
- Developed nanomedia can be incorporated in domestic and community filter
- Filters fluoride and arsenic in low contact time.

6.1.2 Uniqueness of the Developed Device

- No electricity requirement
- High fluoride and arsenic removal efficiency
- Retains all essential mineral ions
- No wastage of water
- Cost effective,
- Usable in domestic level
- User friendly technology
- Safe and sustainable device.

6.2 Equipment and Machinery Required for Deployment :

Oven, furnace, mortar pestle, vacuum pump, mechanical stirrer and distillation unit.

6.3 Duration to the First Output after Installation:

Can provide clean water approximately after an hour of installation.

6.4 Is the Product Output Seasonal or Continuous :

The product is continuous, no seasonal effect.

6.5 Quality and Stability of the Obtained Product :

The filtered water fulfills the criteria of drinking water as per the BIS standard 10500.

6.6 Market Demand of the Product :

In India, gravity water filters are seeing *significant traction* in both **urban and rural households** especially where municipal water quality is moderate and users prefer low-maintenance, electricity-free systems.

Key consumer driver for this present filtration device is :

- No electricity requirement
- Low maintenance & affordability
- Ease of use
- Environmental appeals as no waste water production.

6.7 Resource Required (Raw Material, Energy, Water etc.) for Operationalization of the Technology :

Chemicals (acid, alkali, metal source, distilled water, electricity).

6.8 Climatic and Geographical Conditions Required (Temperature, Rainfall, Humidity, Wind, Train, Soil Condition) :

TDS of the inlet water should be less than 800 mg/l.

6.9 Area Footprint of the Process :

~400 to 500 m² industrial area for 10-50 Kg/day nanoalumina, 400-500 filters/day (details in the following table)

Section	Area (m ²)
Nanoalumina synthesis line	120-150
Drying, calcination & milling	80-100
Filter cartridge production	80-100
QA & water testing lab	40-60
Chemical & raw material storage	30-40
Utilities & effluent treatment	40-50
Offices & circulation	30-40
Total	420-540 m²

6.10 Gestation Period of the Project :

Once all the space, instruments and license is available, the project can be started in 2-3months.

6.11 Economic Unit Size :

Each domestic filter is of size 30x35x45 cm.

6.12 Indicative Investment :

18.0 to 20.0 Lakh.

6.13 Status of Commercialization of the Technology:

Commercialised to 4 companies

- Doctors Water, Kolkata, West Bengal
- IBS Water Nanopurifier, Bhopal
- MWS Social Enterprises Pvt. Ltd., Indore
- Marcus Projects Pvt. Ltd., Lucknow

7. Technology photos (Field installations)

The devices have been tested in the field

- Dhar district for fluoride removal: The filters have been installed in various blocks of Dhar district, Madhya Pradesh, one of the worst-fluoride-affected areas. The devices have been found to work efficiently at the domestic level to provide fluoride free drinking water.
- Karkatpur, Gaziabad district: For arsenic contamination studies, devices have been installed in Karkatpur, where they have worked efficiently in treating arsenic-contaminated water.



Field Demonstration of the Domestic Electricity Free Filter Device for Fluoride Free Drinking Water



For queries, please write to :

The Director

CSIR-Advanced Materials and Processes Research Institute (CSIR-AMPRI)
Hoshangabad Road, Bhopal, Madhya Pradesh



2457244, 2457609 / 2457615



+91-755-2488323



director.ampri@csir.res.in



<http://www.ampri.res.in>



CERAMIC MEMBRANES WITH POSITIVE SURFACE CHARGE FOR DEFLUORIDATION OF CONTAMINATED WATER FOR DRINKING PURPOSE

TRL 5

**CSIR-Central Glass & Ceramic Research Institute
(CSIR-CGCRI), Kolkata - 700 032, West Bengal, India**

1. Name of CSIR Laboratory:

**CSIR-Central Glass & Ceramic Research Institute (CSIR-CGCRI),
Kolkata 700 032, West Bengal, India.**

2. Name of Technology:

Ceramic Membranes with Positive Surface Charge for Defluoridation of Contaminated Water for Drinking Purpose.

3. TRL Level : 5**4. Preamble**

Fluoride contamination of groundwater is a persistent problem in India and the neighbouring countries of Bangladesh and Sri Lanka. As per a study published in 2018, about 9% of the Indian population is at risk of fluorosis from consumption of water contaminated with high level of fluoride. The pooled concentration of fluoride in India has been found to be around 2.37 mg/L which is higher than WHO and Indian standard IS 10500 for drinking water (1.0 mg/L).

The existing methods that are popular for remediation of fluoride are based on adsorption, using alum, activated alumina and charcoal. These processes suffer from disadvantages of passing on residual adsorbents in treated water and production of large quantity of secondary waste. These limitations can be addressed by implementing membrane technology for fluoride remediation.

5. Technical Description

Ceramic nanofiltration (NF) membranes with positive surface charge has been developed for removal of fluoride along with other harmful components for providing safe drinking water in affected areas. Membrane surface charge plays a crucial role in rejection of fluoride ions. The application of positively charged NF membranes in defluoridation is promising to produce quality drinking water.

Yttrium oxide coated charged NF membranes are expected to show high efficiency in fluoride removal from aqueous medium. Positively surface charged yttria nano-powder and yttria coated charged ceramic membranes preparation and their characterization and performance evaluation in defluoridation of simulated solutions and real field contaminated water collected from diverse sources have been evaluated.

6. Design Details**6.1 Salient features**

1. Surface charged nano-powder such as yttria (Y₂O₃) has been prepared using commercially available low-cost chemicals.
2. X-ray study indicates the presence of Y₂O₃ in pure form.
3. Particle size obtained 432 nm.
4. Powder surface area of 21.065 m²/g.

5. Positive surface zeta potential value was measured for the synthesized powder at natural pH range.
6. >99% removal of fluoride in presence of competitive ions such as chloride and nitrate with adsorption capacity of ~45 mgF-/g adsorbent and with permeate concentration well below 0.5 ppm.
7. Membrane study showed encouraging result. Permeate water obtained with fluoride concentration of ~0.8 ppm from a feed of 4.65 ppm.
8. Synthesized powder showed fluoride adsorption capacity above 5 mg/g at natural pH of synthetic solution of 5ppm F- concentration.
9. Regeneration and reuse study of adsorbent has been investigated.
10. Synthesized yttria nano-powder coated ceramic membrane of surface positive charge has been prepared over ceramic microfiltration tubular support of 10mm OD, 7mm ID and 150 mm length.
11. Membrane has been tested for fluoride removal in cross-flow membrane filtration (CMF) mode of operation and showed encouraging result.
12. Membranes having top layer of alumina/boehmite with nominal pore dia of 50nm (UF), 100kDa MWCO (UF) and 5kDa MWCO (UF/NF) have been prepared up to 150 mm length over tubular 10mm OD / 7mm ID ceramic support for various applications.

6.2 IPR Status

No patent is available on the proposed technology to the best of my knowledge.

6.3 Status of commercialization of the technology

Not Commercialized.



For queries, please write to :

Head,

Business development and publication division
196, Raja S.C. Mullick Road, Kolkata – 700 032, West Bengal, India



+91 33 23223544 / 24838079
(3544-Extension)



pmd@cgcri.res.in



director.cgcri@csir.res.in



<http://www.cgcri.res.in>



TRL

8

COMMUNITY LEVEL FLUORIDE REMOVAL PLANT

TRL 8



CSIR- Central Mechanical Engineering Research Institute
(CSIR-CMERI), M.G. Avenue, Durgapur 713209, West Bengal, India

- 1. Name of CSIR Laboratory**
CSIR Central Mechanical Engineering Research Institute (CSIR-CMERI), M.G. Avenue, Durgapur 713209, West Bengal, India.
- 2. Name of Technology**
Community Level Fluoride Removal Plant.
- 3. TRL Level: 8**

4. Preamble

Excess fluoride (>1.5 mg/L) in drinking water, beyond the limits prescribed by WHO and BIS, causes dental, skeletal, and non-skeletal fluorosis. Nearly twenty Indian states and about 10,000 rural habitations are affected. To address this unmet need, a cost-effective, community-level defluoridation technology has been developed for safe drinking water supply in rural areas.

5. Technical Description

The technology is a gravity-based, adsorption-driven community water defluoridation plant designed for removal of excess fluoride from groundwater. The system consists of an overhead sedimentation tank and a multi-compartment filtration unit fitted with SS-302 mesh and specialized adsorbent cartridges. Optional UV/ozonation can be integrated for microbial control, and a backwash facility enables regeneration of filter media.

6. Design Details

6.1 Salient Features

Low-cost, community-level defluoridation system, Gravity-operated (no electricity required for basic operation), Flow rate ~700 LPH, Storage capacity ≥ 1000 L (expandable), Replaceable cartridge system with ~6 months average adsorbent life, Use of naturally abundant and CSIR-CMERI R&D modified adsorbents, Easy operation (layman-friendly prototype).

6.2 Equipment and Machinery Required for Deployment:

Overhead storage tank, multi-compartment filtration unit with SS mesh, replaceable adsorbent cartridges, piping and control valves, support structure, optional UV/ozonator unit, and basic plumbing accessories.

6.3 Duration to the First Output after Installation:

Immediate output after installation and charging of filter media (within a few hours of commissioning).

6.4 Is the Product Output Seasonal or Continuous:

Continuous.

6.5 Quality and Stability of the Obtained Product:

Produces fluoride-safe drinking water within permissible limits (≤ 1.5 mg/L) as per WHO/BIS standards; stable performance with periodic cartridge replacement and backwashing.

6.6 Market Demand of the Product:

High demand in fluoride-affected rural and semi-urban regions across India where centralized piped water supply is not feasible or economically viable.

6.7 Resource Required (Raw Material, Energy, Water etc.) for Operationalization of the Technology:

Raw water (fluoride-contaminated groundwater), naturally abundant and modified adsorbent materials, minimal water for backwashing, and negligible energy (gravity-based system; optional power for UV/Ozonator).

6.8 Climatic and Geographical Conditions Required (Temperature, Rainfall, Humidity, Wind, Train, Soil Condition):

Suitable for rural and semi-urban areas; operable under normal ambient temperature and humidity conditions; no specific soil, rainfall, or wind requirements.

6.9 Area Footprint of the Process:

Compact community-level installation; requires small platform area suitable for village-level deployment.

6.10 Gestation Period of the Project:

Short gestation period; installation and commissioning can be completed within a few weeks.

6.11 Economic Unit Size:

Community-level unit serving a village cluster with minimum 1000 L storage capacity and ~ 700 LPH treatment capacities.

6.12 Indicative Investment:

Moderate initial capital investment with low operational and maintenance cost compared to centralized pipeline systems or RO plants.

6.13 Status of Commercialization of the Technology:

IPR secured (copyright, design registration, and patent filed); technology transferred to 5 agencies (M/s Sarvo Technologies Limited, Faridabad-121005, Haryana, M/s Sre Senthil Engg.Co., A-12, Coimbatore (P) Industrial Estate, Coimbatore-641021, Tamil Nādu, M/s Neesal Commercials Pvt.Ltd., B-50A, Golden Enclave, Najafgarh, New Delhi-110043, Delhi, M/s Dewpure Engineering Pvt Ltd., Garia, Kolkata, M/s. Harambh Chemicals, Baranasi, India) to date and ready for wider commercialization.



For queries, please write to :

Head,

Business Development Unit, CSIR-Central Mechanical Engineering Research Institute (CSIR-CMERI), M.G. Avenue, Durgapur – 713209, West Bengal, India



0343-6510237



director.cmeri@csir.res.in

bdg.cmeri@csir.res.in

Dr. Priyabrata Banerjee



<http://www.cmeri.res.in>

pbanerjee.cmeri@csir.res.in

Mobile: 9433814081



DOMESTIC FLUORIDE REMOVAL UNIT (DOMESTIC WATER FILTER FOR DEFLUORIDATION)

TRL 8



CSIR- Central Mechanical Engineering Research Institute
(CSIR-CMERI), M.G. Avenue, Durgapur 713209, West Bengal, India

1. Name of CSIR Laboratory

CSIR-Central Mechanical Engineering Research Institute (CSIR-CMERI), M.G. Avenue, Durgapur - 713209, West Bengal, India.

2. Name of Technology

Domestic Fluoride Removal Unit (Domestic Water Filter for Defluoridation).

3. TRL Level:

TRL 8 (Technology developed, field-tested in multiple fluoride-affected areas and technology transferred to an industry partner M/s ANTS Ceramics Pvt. Ltd.).



Digital image of the developed filter, its adsorbent materials and its packaging within corrugated box

4. Preamble

High concentrations of fluoride (>1.5 mg/L) in drinking water are harmful to human health and are responsible for dental, skeletal and non-skeletal fluorosis. Groundwater is the primary source of drinking water in rural India, and a large number of rural habitations across at least seventeen Indian states (e.g. Rajasthan, Bihar, Karnataka, West Bengal, Telangana, Jharkhand, Andhra Pradesh, Punjab, Haryana, Uttar Pradesh, Assam, Madhya Pradesh, Maharashtra, Chhattisgarh, Kerala, Odisha and Gujarat) are affected by elevated fluoride levels. In this context, CSIR-CMERI, Durgapur, has developed a low-cost, domestic, non-electrical filtration unit for defluoridation of drinking water, aimed at providing safe potable water to fluorosis-endemic rural and peri-urban regions. The unit is based on adsorption using novel ferrite-impregnated activated alumina along with other adsorbents and is designed to be user-friendly, portable and suitable for household use.

5. Technical Description

The Domestic Fluoride Removal Unit is a non-electrical, gravity-driven, multi-stage adsorption-based water filtration system designed to reduce fluoride concentration in groundwater to below the

permissible limit of 1.5 mg/L, in line with WHO and BIS guidelines. The filter cartridge comprises activated alumina, ferrite (magnesium ferrite, MgFe_2O_4) impregnated activated alumina, silver-impregnated activated carbon, and sand. The ferrite-impregnated activated alumina is prepared by impregnating commercially available activated alumina beads (5-8 mm) with a solution of magnesium nitrate, ferric nitrate and glycine, followed by controlled heating, washing, drying and calcination to form spinel magnesium ferrite on the alumina surface. This novel adsorbent exhibits improved fluoride uptake compared to traditional activated alumina. During operation, fluoride-contaminated water passes sequentially through the adsorbent layers under gravity. Fluoride ions are adsorbed predominantly on the activated alumina and ferrite-impregnated activated alumina, while the silver-impregnated activated carbon reduces microbial activity and improves organoleptic properties. Sand and other layers help in removal of suspended particulates. The unit can effectively reduce fluoride from about 45 ppm (and up to ~6 ppm in tests) to below 1.5 ppm, depending on feed water quality. The typical adsorbent life is around 2000 L of fluoride-contaminated water, with a flow rate of about 5 L/hour and a treated water storage capacity of around 12 L. Water quality has been validated using in-house testing at CSIR-CMERI with a fluoride-selective electrode ion meter (Orion Star A-214, Thermo Scientific, USA), as well as by ISO-certified and NABL-accredited laboratories and Public Health Engineering Laboratories (WB). The unit is suitable for household use in fluoride-affected regions using groundwater (tube wells, wells, etc.) with fluoride concentration up to ~5 ppm.

6. Design Details

6.1 Salient Features

- Non-electrical, gravity-based domestic water filter, suitable for areas with unreliable power supply.
- Multi-stage adsorption system using activated alumina, ferrite-impregnated activated alumina, silver-impregnated activated carbon and sand.
- Demonstrated capability to reduce fluoride from ~45 ppm (tested up to ~6 ppm) to below 1.5 ppm.
- Additional removal of particulate matter and reduction of microbial load.
- Adsorbent life of ~2000 L before replacement, depending on feed water quality.
- Flow rate around 5 L/hour, with treated water storage capacity of ~12 L.
- Portable, compact domestic unit with stainless steel gravity filter container and user-friendly cartridge assembly.
- Based on naturally available and R&D-modified adsorbent materials; indigenous technology.
- Low manufacturing cost per unit, suitable for large-scale dissemination in rural and semi-urban regions.
- Technology validated through laboratory and accredited third-party testing.

6.2 Equipment and Machinery Required for Deployment:

- For preparation of ferrite-impregnated activated alumina (adsorbent):
 - Mechanical stirrer.
 - Stainless steel (SS) containers of 2030 L, 50 L and 100 L capacity.
 - Oven/Furnace for drying and heat treatment of adsorbents.

- For preparing the filter cartridge:
- Nylon filter cloth bags (to hold ~3 kg activated alumina).
- Food-grade plastic container (~1.5 L) for multi-stage cartridge.
- SS mesh and plastic sheet separators to keep adsorbent layers separate.
- For filter assembly:
 - SS-based gravity filter container (~23 L) with tap.
 - Brush-made screwnutwasher nozzle (ID ~6 mm) to support the cartridge.
 - Polymeric pipe (OD ~6 mm; length ~20 cm).

6.3 Duration to the First Output after Installation:

The unit is ready for use immediately after installation, rinsing and initial conditioning. The first batch of safe treated water can typically be obtained within a few minutes (time required to fill the top chamber and pass through the filter by gravity).

6.4 Is the Product Output Seasonal or Continuous:

Continuous/round-the-year operation, subject to regular feeding of source water and periodic replacement of the adsorbent cartridge as per recommended capacity (~2000 L). Performance is not season-dependent; designed for regular household use.

6.5 Quality and Stability of the Obtained Product:

Fluoride concentration in treated water is reduced from ~4-5 ppm (and up to ~6 ppm in tests) to below 1.5 ppm, conforming to WHO/BIS permissible limits for drinking water, depending on feed water quality. Treated water quality has been validated by in-house testing at CSIR-CMERI using a fluoride-selective electrode ion meter (Orion Star A-214, Thermo Scientific, USA), ISO-certified laboratories, Public Health Engineering Laboratories (WB), and NABL-accredited laboratories (Mitra SK Pvt. Ltd., Kolkata). Silver-impregnated activated carbon imparts bacteriostatic properties, helping control microbial growth in the filter. Stable performance of fluoride removal is observed up to approximately 18002000 L of treated water, after which cartridge replacement is recommended.

6.6 Market Demand of the Product:

The unit addresses a critical drinking water problem in at least seventeen Indian states affected by fluoride contamination in groundwater (e.g. Rajasthan, Bihar, Karnataka, West Bengal, Telangana, Jharkhand and others). There is high potential demand in rural and peri-urban habitations where groundwater is the primary drinking water source and centralized defluoridation plants are absent or inadequate. Technology has already been transferred to M/s ANTS Ceramics Pvt. Ltd. and deployed in several fluoride-affected areas in West Bengal (especially Birbhum), indicating recognized market acceptance and demand. The product aligns with public health and government programs targeting fluorosis mitigation and safe drinking water supply.

6.7 Resource Required (Raw Material, Energy, Water etc.) for Operationalization of the Technology:

For manufacturing / cartridge preparation:

- Activated alumina (5-8 mm beads).

- Magnesium nitrate, ferric nitrate and glycine for ferrite impregnation.
- Silver-impregnated activated carbon (coconut shell-based).
- Sand (specified mesh size).
- SS containers, nylon filter cloth, plastic cartridge components, SS mesh/separators, SS filter body, polymeric tubing, etc.
- Electrical energy for solution preparation, stirring and oven/furnace operations (during adsorbent preparation).

For end-user operation:

- Fluoride-contaminated groundwater (e.g. from tube wells, wells) with fluoride concentration preferably ≤ 5 ppm.
- No external energy requirement at point of use (gravity-driven operation).
- Periodic replacement of spent adsorbent/cartridge after ~ 2000 L of treated water.

6.8 Climatic and Geographical Conditions Required (Temperature, Rainfall, Humidity, Wind, Train, Soil Condition):

Designed primarily for rural and peri-urban households in fluoride-affected regions using groundwater. No stringent climatic constraints; suitable for a wide range of Indian climatic conditions (hot, humid, semi-arid etc.) as the unit is used indoors. Recommended water source: tube wells, wells and similar groundwater sources with fluoride levels below ~ 5 ppm. Normal indoor ambient temperature and humidity conditions are adequate; no special requirements related to rainfall, wind or soil, apart from availability of groundwater.

6.9 Area Footprint of the Process:

Compact domestic unit with footprint similar to a conventional 2025 L household gravity water filter. Requires only a small counter-top or stand space in the kitchen/household (sufficient to place the ~ 23 L SS filter container and cartridge).

6.10 Gestation Period of the Project:

For individual household installation: very low gestation period; the unit can be installed and made operational within a day of receipt, after basic rinsing and conditioning. For setting up a small-scale manufacturing/assembly facility: gestation period will mainly depend on procurement of equipment (SS containers, mechanical stirrer, oven/furnace, etc.) and raw materials; it can be implemented as a small-to-medium enterprise with relatively moderate infrastructure.

6.11 Economic Unit Size:

One domestic filter unit (~ 12 L treated water storage, ~ 5 L/h flow) is adequate for a typical household of ~ 46 members in fluoride-affected regions. Manufacturing can be scaled from small batch production (tens of units per month) to larger capacities depending on regional demand.

6.12 Indicative Investment:

Approximate manufacturing cost per domestic filter unit as per technology document is as follows:

- SS filter container with tap: INR 550

- Activated alumina (3 kg): INR 450
- Ferrite-impregnated activated alumina (1 kg): INR 180
- Silver-impregnated activated carbon: INR 40
- Sand: INR 10
- Filter cloth and brush-based screw-nut-nozzle: INR 100
- Total indicative manufacturing cost per unit: ~INR 1330 (excluding overheads, labour, packaging, taxes and margins). Additional investment required for setting up adsorbent preparation and assembly facility (equipment, workspace and initial inventory) will depend on chosen production scale.

6.13 Status of Commercialization of the Technology:

Technology developed and demonstrated by CSIR-CMERI, Durgapur. Domestic defluoridation filters have been deployed in several fluoride-affected areas in West Bengal (notably Birbhum district). Technology has been transferred to M/s ANTS Ceramics Pvt. Ltd. for commercialization. Performance has been validated through in-house and external accredited laboratories.

7. Technology photos (Field installations)



Installation of domestic water filter (defluoridation) at the Office of CMOH, Suri, Birbhum district, West Bengal



For queries, please write to :

Head,

Business Development Unit, CSIR-Central Mechanical Engineering Research Institute (CSIR-CMERI), M.G. Avenue, Durgapur – 713209, West Bengal, India



0343-6510237



director.cmeri@csir.res.in
bdg.cmeri@csir.res.in



<http://www.cmeri.res.in>



HIGH FLOW RATE FLUORIDE & IRON REMOVAL PLANT

TRL 7-8



CSIR- Central Mechanical Engineering Research Institute
(CSIR-CMERI), M.G. Avenue, Durgapur 713209, West Bengal, India

1. Name of CSIR Laboratory

CSIR-Central Mechanical Engineering Research Institute (CSIR-CMERI), M.G. Avenue, Durgapur 713209, West Bengal, India.

2. Name of Technology

High Flow Rate Fluoride & Iron Removal Plant.

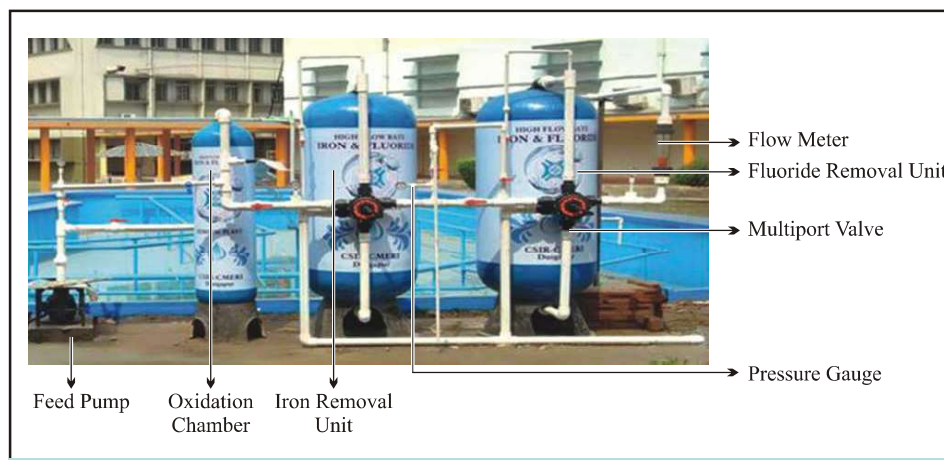
3. TRL Level: 7-8**4. Preamble**

Groundwater contamination by fluoride and iron is a severe public health issue in India, affecting millions of people. Excess iron (>0.3 ppm) and fluoride (>1.5 ppm) in drinking water can lead to liver disease, irregular heart rhythm, neuronal disorders, dental and skeletal fluorosis, among other health problems. To address this dual contamination challenge, CSIR-CMERI has developed a low-cost, integrated, multi-adsorbent community-level water purification system capable of simultaneously removing fluoride and iron efficiently, even at high flow rates.

5. Technical Description

The CSIR-CMERI Fluoride and Iron Removal System is a three-stage water purification system: **Chamber-I:** FRP vessel for rapid precipitation and removal of iron. **Chamber-II:** Secondary stage for thorough removal of residual iron. **Chamber-III:** Fluoride removal unit using naturally abundant or indigenously developed CSIR-CMERI patented adsorbents packed in proper weight ratios. The system achieves a flow rate of ~10,000-12,000 liters per hour, continuously monitored with flow meters and pressure gauges. Iron concentration is reduced from ~9 ppm to <0.3 ppm, and fluoride from ~12 ppm to <1.5 ppm, meeting WHO safety guidelines.

6. Design Details**6.1 Salient Features**

- Dual contaminant mitigation: simultaneous removal of fluoride and iron, Integrated adsorbent-

based purification system, High throughput: 10,00012,000 liters/hour, Selective backwash without dismantling plant components.

6.2 Equipment and Machinery Required for Deployment:

- FRP vessels for Chambers III, Flow meters and pressure gauges, Adsorbent packing materials (naturally abundant or CSIR-CMERI patented), Pumps and piping for water movement, Backwash system.

6.3 Duration to the First Output after Installation:

Immediate operation after commissioning; purified water is available continuously once installed and filled with adsorbents.

6.4 Is the Product Output Seasonal or Continuous:

Continuous.

6.5 Quality and Stability of the Obtained Product:

Iron: reduced to <0.3 ppm, Fluoride: reduced to <1.5 ppm, Meets WHO drinking water standards, Stable performance with regular maintenance and selective backwash.

6.6 Market Demand of the Product:

High demand in rural and semi-urban areas with fluoride and iron contamination. Applicable to NGOs, water supply organizations, and community water projects.

6.7 Resource Required (Raw Material, Energy, Water etc.) for Operationalization of the Technology:

Raw materials: naturally abundant or CSIR-CMERI developed adsorbents, Energy: electricity for pumps and monitoring instruments, Water: contaminated groundwater to be treated, Minimal additional resources for maintenance.

6.8 Climatic and Geographical Conditions Required (Temperature, Rainfall, Humidity, Wind, Train, Soil Condition):

Can be deployed in diverse climatic conditions, Effective in areas with standard ambient temperatures, rainfall, humidity, and wind conditions, Soil conditions not critical, as plant is modular and installed above or near the water source.

6.9 Area Footprint of the Process:

Community-level plant; compact modular design suitable for small localities or institutional setups. Specific area depends on installation size but generally minimal due to modular design.

6.10 Gestation Period of the Project:

Immediate deployment possible; installation to first output: few days for commissioning and packing adsorbents.

6.11 Economic Unit Size:

Designed for community-level capacity of 10,00012,000 liters/hour.

6.12 Indicative Investment:

Total project cost: ₹40.00 lakhs, Manpower (2 persons): ₹14.88 lakhs, Consumables: ₹22.62 lakhs, Contingencies: ₹1.0 lakh, Travel: ₹1.5 lakh.

6.13 Status of Commercialization of the Technology:

Copyright Filed: CSIR-CMERI/QIPMG/Copyright/2019-20/146.

Technology transferred to M/s. Capricans Aqua Private Limited, Howrah, for deployment in Bihar.



For queries, please write to :

Head,

Business Development Unit, CSIR-Central Mechanical Engineering Research Institute (CSIR-CMERI), M.G. Avenue, Durgapur – 713209, West Bengal, India



0343-6510237



director.cmeri@csir.res.in

bdg.cmeri@csir.res.in

Dr. Priyabrata Banerjee



<http://www.cmeri.res.in>

pbanerjee.cmeri@csir.res.in

Mobile: 9433814081



COMMUNITY/DOMESTIC LEVEL FLUORIDE, ARSENIC & IRON REMOVAL (FAIR) TECHNOLOGY

TRL 7-8



CSIR- Central Mechanical Engineering Research Institute
(CSIR-CMERI), M.G. Avenue, Durgapur 713209, West Bengal, India

1. Name of CSIR Laboratory

CSIR-Central Mechanical Engineering Research Institute (CSIR-CMERI), M.G. Avenue, Durgapur 713209, West Bengal, India.

2. Name of Technology

Community/Domestic Level Fluoride, Arsenic & Iron Removal (FAIR) Technology.

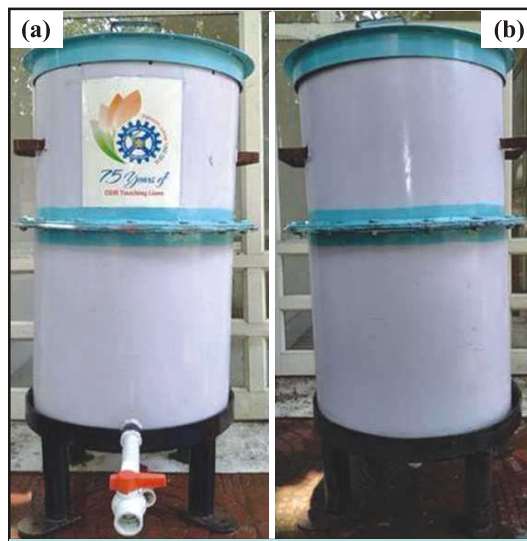
3. TRL Level: 7-8**4. Preamble**

A cost effective, gravitational based community level Fluoride, Arsenic and Iron Removal (FAIR) technology has been engineered, designed and subsequently developed by CSIR-CMERI for producing safe drinking water within the permissible limit of iron, fluoride & arsenic from highly contaminated ground water resources, *i.e.*, 3-Problems-1-Solution.

5. Technical Description

Indigenous, gravity-driven, two-stage integrated adsorption-based community/domestic water filtration system (FAIR Technology) for simultaneous removal of fluoride, iron, and arsenic from contaminated groundwater using multifunctional natural and chemically modified adsorbents in replaceable cartridges.

6. Design Details**6.1 Salient Features**

- Water storage capacity: ~1200L, Flowrate: ~800-900 L/hr, Cartridges : 4 Nos (replaceable), Purification: 2 stages, System requires less space for installation, Adsorbent life (average): ~6 to 7 month, Filtration efficiency: Arsenic: <10ppb; Iron:< 0.3 ppm, Fluoride < 1.5 ppm, In-house certified by CSIR-CMERI, recognized by West Bengal Pollution Control Board (WBPCB),

Technology/Know-how cost: Rs 6,50,000 /-, No daily maintenance is required; however simple backwash followed by rinsing would enhance the effectivity of the fabricated plant, Layman's prototype, Treated water Cost ~08 paisa/L.

6.2 Equipment and Machinery Required for Deployment:

- Water storage tanks, filtration unit with cartridges and filter media, connecting pipes and valves, supporting stand/platform, basic plumbing fittings, and simple installation tools; no electrical equipment required (gravity-based operation).

6.3 Duration to the First Output after Installation:

Immediate water output upon installation and charging, after initial flushing of the filtration media.

6.4 Is the Product Output Seasonal or Continuous:

Continuous.

6.5 Quality and Stability of the Obtained Product:

Treated water meets WHO drinking water standards with contaminant levels reduced below permissible limits and consistent performance under designed flow rate (800900 L/hr).

6.6 Market Demand of the Product:

High demand in rural and arsenic-, fluoride-, and iron-affected regions where safe, low-cost, electricity-free community water purification systems are required for drinking water compliance with health standards.

6.7 Resource Required (Raw Material, Energy, Water etc.) for Operationalization of the Technology:

Naturally available geomaterials and modified biomaterials (e.g., treated clay, sand, gravel, zinc-impregnated biomass), contaminated groundwater as feed, and no external energy source (gravity-based operation).

6.8 Climatic and Geographical Conditions Required (Temperature, Rainfall, Humidity, Wind, Train, Soil Condition):

Suitable for diverse climatic and geographical conditions; particularly deployable in rural, groundwater-dependent regions without specific environmental constraints.

6.9 Area Footprint of the Process:

Compact community-scale installation with minimal land requirement (small platform-based setup) and IP protected.

6.10 Gestation Period of the Project:

Short gestation period with rapid installation and commissioning.

6.11 Economic Unit Size:

Community-level unit with ~1200 L storage capacity and ~800900 L/hr treatment capacity.

6.12 Indicative Investment:

Low to moderate capital investment with minimal operational cost due to power-free and low-maintenance design.

6.13 Status of Commercialization of the Technology:

The FAIR technology by CSIR-CMERI, Durgapur, has been successfully demonstrated at pilot scale for simultaneous removal of fluoride, arsenic, and iron from groundwater. It is IPR protected (Ref. D12CR2019 & 0177NF2019), eco-friendly, cost-effective, and easy to operate. The technology is ready for scaling and commercial deployment in fluoride-, arsenic-, and iron-endemic regions. Technology transferred to M/s Zenith Aquatech, Shibpur, Howrah 711102, WB.



For queries, please write to :

Head,

Business Development Unit, CSIR-Central Mechanical Engineering Research Institute (CSIR-CMERI), M.G. Avenue, Durgapur – 713209, West Bengal, India



0343-6510237



director.cmeri@csir.res.in

bdg.cmeri@csir.res.in

Dr. Priyabrata Banerjee



<http://www.cmeri.res.in>

pbanerjee.cmeri@csir.res.in

Mobile: 9433814081



FAST AND SAFE DEFLUORIDATION OF WATER USING ALUMINA

TRL 4

CSIR-Central Salt and Marine Chemical Research Institute
(CSIR-CSMCRI), Bhavnagar-364 002, Gujarat, India

1. Name of CSIR Laboratory:

CSIR-Central Salt and Marine Chemical Research Institute (CSIR-CSMCRI), Bhavnagar - 364 002, Gujarat.

2. Name of Technology:

Fast and safe defluoridation of water using alumina.

3. TRL Level: 4

(Tested at the laboratory for 150 L water batch. Patented and mechanism published)

4. Preamble

Removing fluoride from groundwater using alumina.

5. Technical Description

- Process for alumina suitable for defluoridation;
- Demonstration of the process; Know-how license fee details are available on request.

6. Design Details**6.1 Salient Features**

Advantages over earlier attempts:

- Easy to set up: Setup involves a gravity-fed flow from a 3-foot height difference.
- Fast Process: Flow rate of treated water is 45 LPH per 1 kg of alumina, ~15x.
- Safe Chemicals: Safe chemicals were used for all steps.
- Cyclic & Single Reactor: All steps involved in 3 cycles, i.e., pre-treatment of alumina, fluoride removal from water, and regeneration of alumina, were performed in a single reactor.
- The process employs safer versions of earlier-used chemicals.

6.2 Equipment and Machinery Required for Deployment:

- Overhead or any other tank at 4 feet in height, with a pump for filling water.

6.3 Market Demand of the Product:

- This process can be used to upgrade community level alumina based defluoridation plants.

6.4 Resource Required (Raw Material, Energy, Water etc.) for Operationalization of the Technology:

- Alumina (suitable for defluoridation).

6.5 Economic Unit Size:

Cost estimated for 2000 L of treated water per day

- Total investment cost for alumina, overhead tank, pump, and pipes - ₹13,000
- Raw material cost per day 2000 L- ₹781
- Alumina to be used as procured (1 kg - ₹100)

- Regeneration via acid/base produces a solution discarded
- Fluoride in treated water <1.5 ppm
- Regeneration capacity is ~ 100%.

6.6 Status of Commercialization of the Technology:

- IN 2510DEL2014.
- Not yet licensed.



For queries, please write to :

Head,
Business Development & Information Management, CSIR-Central Salt and Marine
Chemical Research Institute (CSIR-CSMCRI), Bhavnagar – 364 002, Gujarat



0278-2567462,
Extn. No.: 7800



kamlesh.csmcri@csir.res.in
bdim.csmcri@csir.res.in



director.csmcri@csir.res.in



<http://www.csmcri.res.in>

SOLAR ASSISTED ELECTROLYTIC DEFLUORIDATION (EDF) TECHNOLOGY

TRL 9



CSIR-National Environmental Engineering Research Institute
(CSIR-NEERI), Nagpur - 440020, Maharashtra, India

1. **Name of CSIR Laboratory**
CSIR-National Environmental Engineering Research Institute (CSIR-NEERI), Nagpur - 440 020, Maharashtra, India.
2. **Name of Technology**
Solar Assisted Electrolytic Defluoridation (EDF) Technology.
3. **TRL Level: 9**
Actual system proven in operational environment.

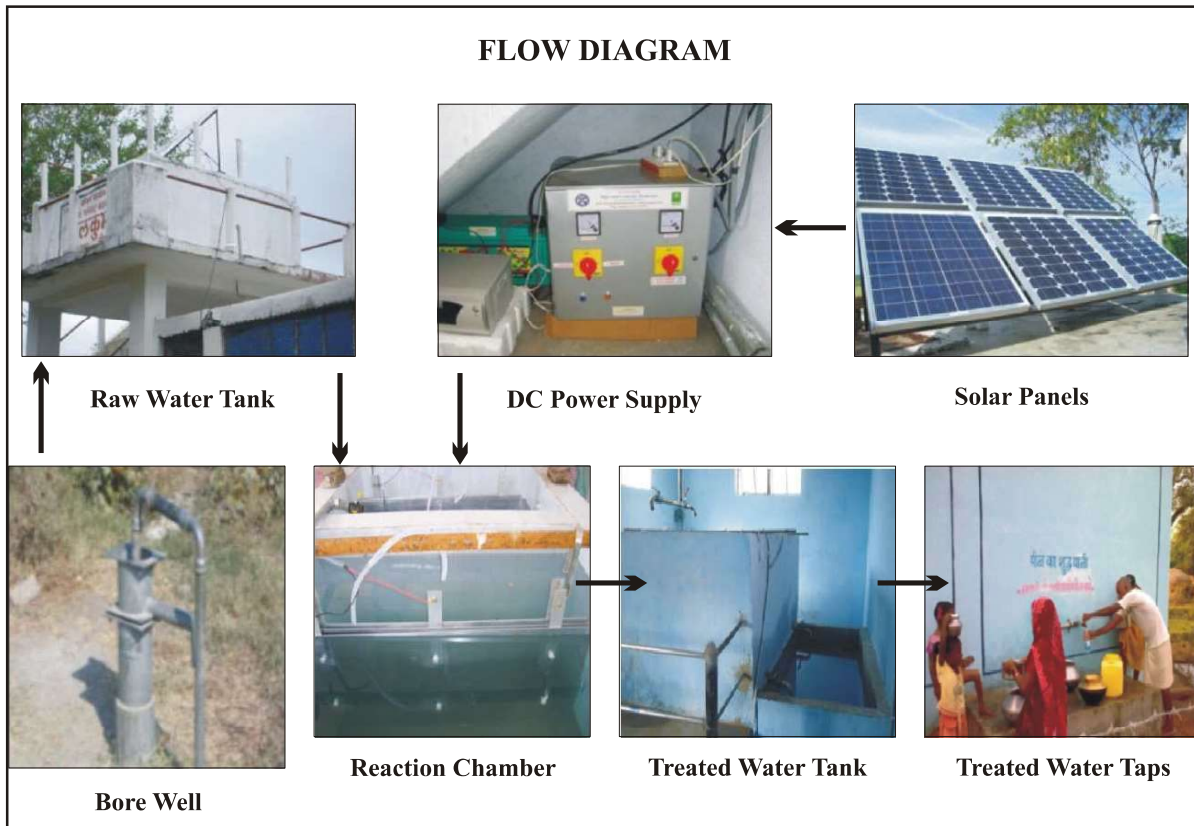

4. Preamble

In India, 85% of rural water supply depends on groundwater. Excess fluoride is ingested through water, food and air. There are several million people in India exposed to drinking water sources with high fluoride content. Excess fluoride ingestion through drinking water is a major problem. It is reported that 20 States and Union Territories in India are endemic for fluorosis due to the consumption of water containing excess fluoride, particularly in rural areas.

NEERI has been working on defluoridation since the Institute's inception. Several materials have been studied in the laboratory and on a pilot scale for defluoridation. The electrolytic defluoridation system uses a totally new concept for the treatment of safe potable water supply in fluoride-affected areas, particularly in villages with no electric supply and no alternate safe water source. Due to the

discontinuous power supply in rural areas, the technology was designed accordingly, supported by Solar Energy.

The electrolytic defluoridation process consists of generating coagulating agents, such as metal hydroxides, through electrolysis. The electrolytic defluoridation unit, in its simplest form, consists of an electrolytic cell with a direct current source connected to a pair of electrodes immersed in the water to be defluoridised. When aluminium electrodes are used, current is passed through them. The aluminium species act as a coagulant by combining with the fluoride ions present in the water to form large size flocs. The sludge obtained is allowed to settle at the bottom and is removed by filtration.

The technology package developed for defluoridation of water will help the Ministry of Drinking Water and Sanitation, Govt. of India, implement the technology in fluorosis-endemic areas in India. The intended end users are the rural population in fluoride-affected areas across various states. Based on the studies, solar-powered electrolytic defluoridation demonstration units were installed at Dongargaon in Warora taluka of Chandrapur district in 2008, at Usarwara village in Durg district, Chhattisgarh State, in 2008, and at Sargapur village in Seoni District (M.P.) in 2010.

There were requests to design units for schoolchildren where drinking water sources were contaminated with fluoride. Therefore, a school-based EDF unit of 200 L capacity was designed and installed at the Girls Hostel in Adivasi Kanya Shiksha Parisar, District Chindwada (M. P.).

The health surveys were undertaken in villages before and after the installation of the electrolytic defluoridation demonstration plant. The result indicates a significant reduction in fluoride-related health complaints, such as Gastrointestinal complaints, polyurea/polydypsea, muscle weakness, and aches and pain in major joints. Thus, due to the implementation of the defluoridation system, the following impacts are envisaged:

- Reduction in dental and skeletal fluorosis cases in the fluoride-affected areas.
- Reduction in expenditure for medical treatment due to drinking water from contaminated sources
- Reduction in epidemic, morbidity, and mortality rates due to waterborne diseases, thereby improving the quality of life.

The sludge generated in the process is about 60-70% less than that of the other defluoridation process. So the cost of sludge disposal and the environmental impacts of improper sludge disposal are lower than those of other defluoridation processes.

This technology was developed for societal welfare, providing a safe water supply to rural communities in fluoride-affected areas.

5. Technical Description

a. Patent Granted

Patent No.: 323864 (granted on 29/10/2019)

Patent Application No. : 2353/DEL/2008

Date of Filing: 14/10/2008

b. Technique

- Electrolytic defluoridation is a water treatment process in which aluminium hydroxide anions are produced by passing direct current through an aluminium electrode.
- The principal reactions involved in electrolysis for defluoridation are as follows.

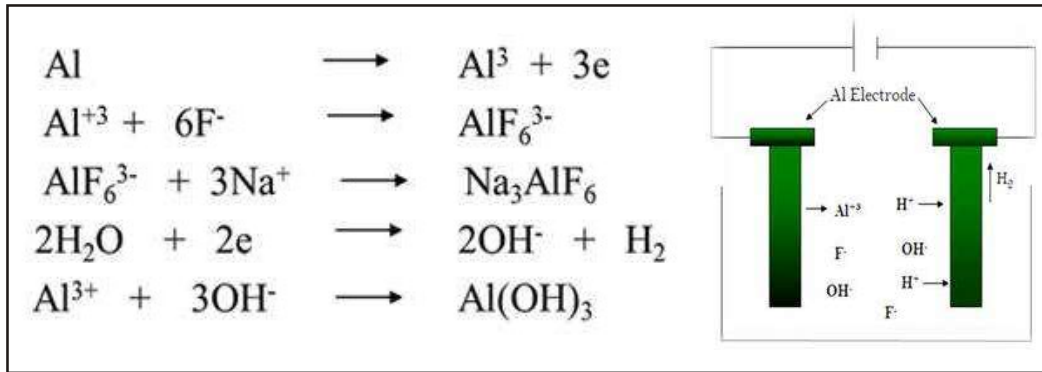

6. Design Details

6.1 Salient Features

Unique features of the technology:

- Simple to fabricate, easy to operate, with minimum maintenance
- Suitable for the treatment of raw water with a fluoride concentration upto 10mg/L
- Produces potable water with a palatable taste compared to the other available chemical treatment methods
- The quantity of sludge produced is much less (60-70%) than conventional treatment methods
- Simultaneous reduction in hardness, nitrate and bacterial contamination in treated water
- Treatment cost upto Rs. 12 per 1000 L
- Can be operated using Solar Energy
- Can be configured to any design capacity
- Operation and maintenance by an unskilled operator
- Successfully implemented in the field, with several plants operating in fluorosis-endemic areas.

The present system provides a technically sound, cost-effective, and reliable community drinking water defluoridation system for supplying drinking water that meets the World Health Organisation (WHO) /ISO guideline value for fluoride. It is well-suited for situations in which the electrical supply is unavailable for extended periods, and the operators and maintenance workers are not highly trained technicians, such as in rural or remote locations.⁶

6.2 Equipment and Machinery Required for Deployment:

- Civil structure
- Pipes
- Control valve
- Hopper bottom reactor

- Aluminium plates
- Insulated fittings
- Wires to the anode and cathode
- A battery is charged through Solar Photovoltaic Cells (PVC) installed on the plant's roof.



6.3 Duration to the First Output after Installation:

Immediately after the installation of the treatment unit

6.4 Is the Product Output Seasonal or Continuous:

The product is designed for the continuous supply of fluoride-free treated water for cooking and drinking water requirements in water-quality-affected areas.⁶

6.5 Quality and Stability of the Obtained Product:

Approximately 500 community-based electrolytic defluoridation units, with varying treatment capacities, have been installed across different water quality-affected areas in India. The technology has been extensively field-tested and has demonstrated strong robustness, accuracy, reliability, and cost-effectiveness. The technology is in compliance with various National and International guidelines/regulatory requirements.

6.6 Market Demand of the Product:

- Government Agencies responsible for providing safe drinking water in the fluoride-affected rural areas
- National and international agencies such as the WHO and UNICEF working to provide safe water to the community.
- NGOs
- Technology can be transferred to an entrepreneur.

6.7 Resource Required (Raw Material, Energy, Water, etc.) for operationalization of the technology:

Human resources unskilled personnel are required to operate the treatment unit.⁶

6.8 Climatic and Geographical Conditions Required (Temperature, Rainfall, Humidity, Wind, Train, Soil Condition):

Climatic and Geographical Conditions do not affect the treated water quality.

6.9 Economic Unit Size:

The EDF treatment unit could be customized to meet the treatment water requirements.

6.10 Indicative Investment:

Depend on the treatment capacity of the unit

6.11 Status of commercialization of the Technology:

- Know-how of EDF Technology transferred to 13 MSMEs; and
- State Water Supply Departments install 491 EDF plants to provide safe water.

7. Technology photos (Field installations)



Adivasi Kanya Shiksha Parisar, District Chindwada (M. P.)



Sargapur, Seoni Dist. (M.P.)



Usarwara village in Durg Dist. (C.G.)



International Project Innovation Award (PIA) instituted by International Water Association (IWA)



The DST-Lockheed Martin India and FICCI Innovation Growth Program Award 2012



For queries, please write to :

Director,

CSIR-National Environmental Engineering Research Institute
(CSIR-NEERI), Nehru Marg, Nagpur-440020, Maharashtra, India



+91-712-2249999



director.neeri@csir.res.in
Dr. Atul Maldhure,
Dr. G. K. Khadse,
Dr. Paras Ranjan Pujari,
WRG, CSIR-NEERI



+91-712-2249900



<http://www.neeri.res.in>
atul.maldhure@csir.res.in,
gajanan.khadse@csir.res.in,
paras.pujari@csir.res.in

CHEMO-DEFLUORIDATION PROCESS FOR REMOVAL OF FLUORIDE FROM DRINKING WATER

TRL 8

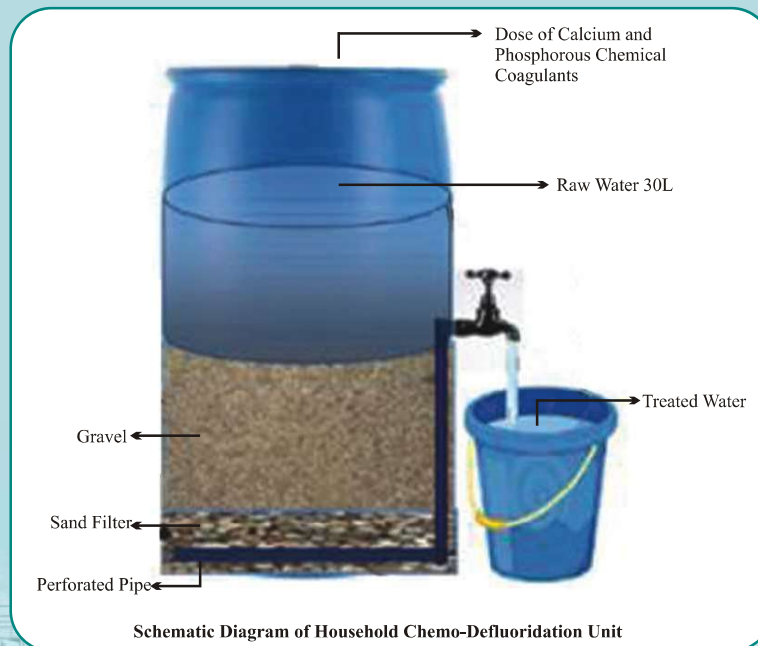

CSIR-National Environmental Engineering Research Institute
(CSIR-NEERI), Nagpur - 440020, Maharashtra, India

- 1. Name of CSIR Laboratory**
CSIR-National Environmental Engineering Research Institute (CSIR-NEERI),
Nagpur - 440 020, Maharashtra, India.
- 2. Name of Technology**
Chemo-Defluoridation Process for removal of fluoride from drinking water.
- 3. TRL Level: 8**
TRL 8 - System complete and qualified.



4. Preamble

Chemo-defluoridation is a process in which the addition of a calculated dose of chemical coagulant, i.e. salts of calcium and phosphorous, is used to achieve a treated water fluoride concentration below 1 mg/L. The process is free of interference from other competitive anions in water and does not affect water palatability. Calcium and phosphorus salts are added to fluoride-containing water; they react with fluoride ions to form insoluble complexes, which then precipitate from the water. The precipitate, along with treated water, is then passed through the sand filter, and the precipitate gets separated out from the treated water, forming a thin layer on the sand bed surface. The treated water with a fluoride concentration below the permissible limit of 1.0 mg/L is collected in the treated water container and can be used for portable use. The thin layer of precipitate formed on the sand bed can be removed manually. The filter may become blocked and need cleaning after about 1 month of continuous operation.

Chemical defluoridation is suitable for providing safe, potable water in fluoride-affected areas. The Chemo-defluoridation can be operated at the domestic and community levels. It is based on the principle of reaction between two chemicals added to fluoride-containing water, precipitation, and the formation of a complex with fluoride in water, followed by adsorption and removal of fluoride by settling on a specially designed sand filter bed.

The intended end users are the rural population in fluoride-affected areas across various states.

S.No.	Year	Place	No. of Units
1.	2010	Sakhra Village, Yavatmal District, Maharashtra	82 Units
2.	2012	Chichkavatha Village, Nagpur District, Maharashtra	30 Units
3.	2018	Nawada Village, Bihar	05 Units

5. Technical Description

a. Patent Granted

Patent No.: 286791 (granted on 29/08/2017)

Patent Application No. : 1242/DEL/2008

Date of Filing:19/05/2008

b. Novel features of the technology:

- Simple to fabricate and easy to operate,
- Minimum maintenance,
- Gravity operated,
- No power requirement,
- The taste of the treated water is palatable
- Typical Capacity - 30 L

6. Design Details

6.1 Salient Features

- Process involves the formation of insoluble fluoride complex with salts of calcium and phosphorous and filtration through sand filter
- Reduces the fluoride concentration in water to <1 mg/L
- A typical unit of 30 L capacity can serve a family of 5-6 persons, based on 5-6 litres per capita/day for drinking and cooking purposes
- Suitable for treating the water upto fluoride concentration of 10 mg./L
- No leaching of fluoride from sludge back into the water at normal pH range (6.5 8.5)
- Most reliable for small fluoride affected villages where a community water treatment plant is not economically feasible
- Unit cost: Rs. 2,000-3,000; operating cost: Rs. 0.20 per litre.

6.2 Equipment and Machinery Required for Deployment:

- Materials
- Container (Plastic/Steel)
- Tub (Plastic/Steel)
- Taps (Plastic/Steel)
- Filter Sand
- Gravel
- Nylobolt cloth.

6.3 Duration to the First Output after Installation:

Immediately after installation.

6.4 Is the Product Output Seasonal or Continuous:

The product output is continuous, as per the requirements of the treated water.

6.5 Quality and Stability of the Obtained Product:

Treated water is safe for drinking and cooking purposes. The technology is in compliance with various National and International guidelines/regulatory requirements.

6.6 Market Demand of the Product:

The product has strong demand for household fluoride treatment units, especially in rural areas with water quality issues.

6.7 Climatic and Geographical Conditions Required (Temperature, Rainfall, Humidity, Wind, Train, Soil Condition):

Not require any climatic or geographical conditions.

6.8 Economic Unit Size:

The chemo defluoridation unit is a household defluoridation unit. The treatment unit would have a capacity of 40 to 60 L.

6.9 Indicative Investment:

The cost of each chemo-defluoridation unit is Rs.2000/- to Rs. 3000/-.

6.10 Status of Commercialization of the Technology:

The technology is ready for transfer and commercialization.



Chichkavatha Village, Nagpur District

Sakhra Village, Yavatmal District

**For queries, please write to :****Director,**

CSIR-National Environmental Engineering Research Institute
(CSIR-NEERI), Nehru Marg, Nagpur-440020, Maharashtra, India



+91-712-2249999



director.neeri@csir.res.in
Dr. Atul Maldhure,
Dr. G. K. Khadse,
Dr. Paras Ranjan Pujari,
WRG, CSIR-NEERI



+91-712-2249900



<http://www.neeri.res.in>
atul.maldhure@csir.res.in,
gajanan.khadse@csir.res.in,
paras.pujari@csir.res.in



DEFLUORIDATION NALGONDA TECHNIQUE

TRL 9



CSIR-National Environmental Engineering Research Institute
(CSIR-NEERI), Nagpur - 440020, Maharashtra, India

1. **Name of CSIR Laboratory**
CSIR-National Environmental Engineering Research Institute (CSIR-NEERI),
Nagpur - 440 020, Maharashtra, India.
2. **Name of Technology**
Defluoridation Nalgonda Technique.
3. **TRL Level: 9**

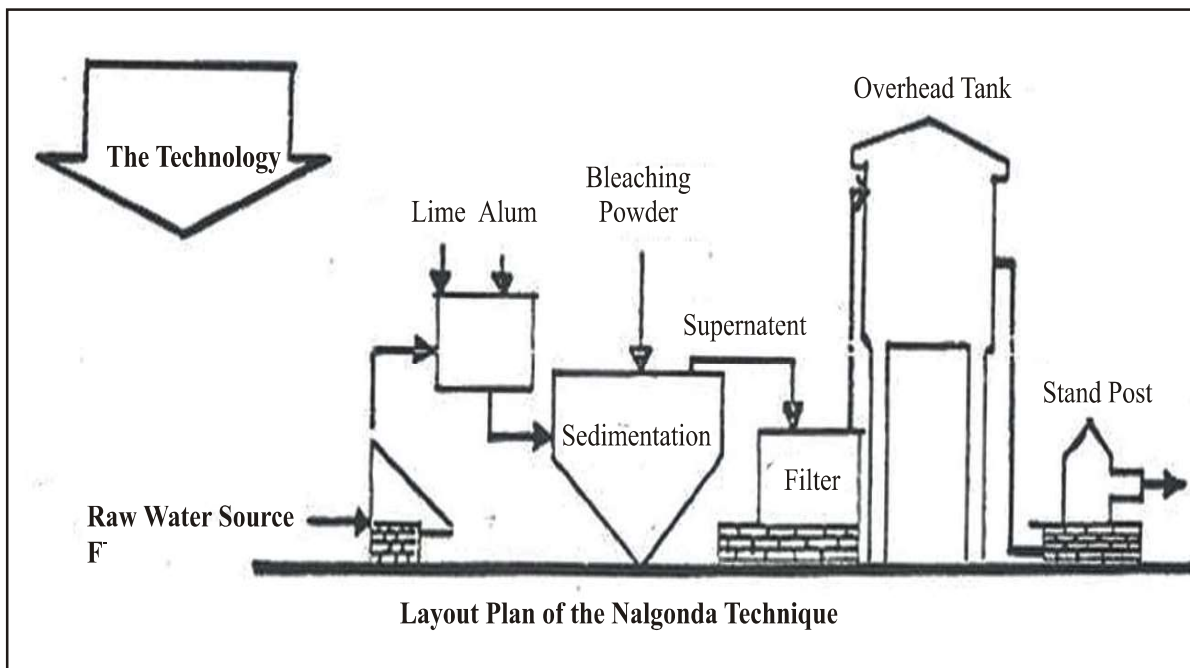

4. Preamble

After extensive testing of many materials and processes since 1961, NEERI has developed an economical, simple method for removing fluoride, known as the Nalgonda Technique. Nalgonda technique is the first-of-its-kind technology for removing fluoride from water.

The Nalgonda Technique, developed by NEERI, involves adding aluminium salt, lime, and bleaching powder, followed by rapid mixing, flocculation, sedimentation, filtration, and disinfection. Aluminium salt may be added as aluminium sulphate, aluminium chloride, or a combination of the two. Aluminium salt is only responsible for removing fluoride from water. The aluminium salt dose increases with increasing fluoride and alkalinity levels in the raw water. The selection of either aluminium sulphate or aluminium chloride also depends on the sulphate and chloride contents of the raw water to avoid exceeding their permissible limits. The dose of lime is empirically $1/20^{\text{th}}$ that of the dose of aluminium salt. Lime facilitates the formation of denser floc or rapid settling. Bleaching powder is added to the raw water at the rate of 3 mg/L for disinfection. Approximate doses of alum required to obtain a permissible limit (1 mg F/L) in water at various fluoride and alkalinity levels are given in the Table.

Table: Approximate Alum Dose (mg/L) required to Obtain Permissive Limit (1 mg F/L) of Fluoride in Water at Various Alkalinity and Fluoride Levels

Test Water Fluorides, mg F/L	Test Water Alkalinity, mg CaCO ₃ /L							
	125	200	300	400	500	600	800	1000
2	145	220	275	310	350	405	470	520
3	220	300	350	405	510	520	585	765
4	*	400	415	470	560	600	690	935
5	*	*	510	600	690	715	885	1010
6	*	*	610	715	780	935	1065	1210
8	*	*	*	*	990	1120	1300	1430
10	*	*	*	*	*	*	1510	1690

* To be treated after increasing the alkalinity with lime or sodium carbonate.

5. Technical Description

Mechanism of Defluoridation by the Nalgonda Technique

Nalgonda Technique is a combination of several unit operations and processes that incorporate rapid mixing, chemical interaction, flocculation, sedimentation, filtration, disinfection, and sludge concentration to recover water and aluminium salts.

Rapid Mix

Provides thorough mixing of alkali, aluminium salts, and bleaching powder with water. The chemicals are added just when the water enters the system.

Flocculation :

Flocculation provides subsequent gentle agitation before entry to the sedimentation tank. The flocculation period allows close contact between the fluoride in water and the polyaluminum species formed in the system. The interaction between fluoride and aluminium species attains equilibrium.

The chemical reaction involving fluorides and aluminium species is complex. It is a combination of polyhydroxy aluminium species complexation with fluorides and their adsorption on polymeric alumina hydroxides (floc). Besides fluorides, turbidity, colour, odour, pesticides and organics are also removed. The bacterial load is also reduced significantly. All these are adsorbed onto the floc. Sodium carbonate or sodium bicarbonate ensures adequate alkalinity for effective hydrolysis of aluminium salts, so that residual aluminium does not remain in the treated water. The reactions depend on the nature of the alkalinity.



Sedimentation:

Permits settleable floc loaded with fluorides, turbidity, bacteria, and other impurities to be deposited, thereby reducing the concentration of suspended solids that are removed by filters. Sedimentation theory is complex and of little avail because floc is not uniform, so its basic sedimentation properties cannot be assigned quantitative values, and the influence of eddy currents cannot be predicted. Hence, various factors which influence sedimentation in relation to design and operation rely largely on experience.

Filtration:

Rapid gravity sand filters are designed to receive coagulated and settled water. Any unsettled gelatinous floc is retained on the filter bed. Residual fluorides and bacteria are adsorbed onto this gelatinous floc, which is retained within the filter media.

Disinfection and Distribution:

The filtered water collected in the storage water tank is re-chlorinated with bleaching powder before distribution.

When to Adapt the Nalgonda Technique

- Absence of an acceptable alternate low fluoride source
- Dissolved solids are below 1500 mg/L
- Total hardness is below 250 mg/L
- The alkalinity of the water is sufficient
- Raw water fluorides ranging from 2 to 20 mg F/L

The Nalgonda Technique is a simple, low-cost method of defluoridation that the general public can easily adopt. It is suitable for both domestic and community-level water treatment. The process can operate under fill-and-draw as well as continuous flow systems for community water supply. It remains effective even when the fluoride concentration exceeds 20 mg/L, total dissolved solids exceed 1500 mg/L, and water hardness exceeds 250 mg/L.

6. Design Details**6.1 Salient Features**

- No regeneration of media
- No handling of caustic acids and alkalies
- Readily available chemicals used in conventional municipal water treatment are only required.
- Adoptable to domestic use
- Flexible up to several thousand m³/d
- Applicable in batch as well as in continuous operation to suit needs
- Simplicity of design, construction, operation and maintenance
- Local skills could be readily employed

- Highly efficient removal of fluorides from 2 to 20 mg F/L to desirable levels
- Simultaneous removal of colour, odour, turbidity, bacteria and organic contaminants
- Typically, associated alkalinity ensures fluoride removal efficiency
- Sludge generated is convertible to alum for use elsewhere
- Little wastage of water and minimal disposal problem
- Needs a minimum of mechanical and electrical equipment
- No energy except muscle power for domestic equipment
- Economical-annual cost of defluoridation of water at 40 lpcd works out to Rs. 20/- for domestic treatment and Rs. 85/- for community treatment using fill-and-draw system based on 5000 population for water with 5 mg F/L and 400 mg/L alkalinity, which requires 600 mg/L alum dose
- Provides defluoridated water of uniform acceptable quality.

6.2 Equipment and Machinery Required for Deployment:

Required the extensive construction and infrastructure to set up the community based fluoride treatment unit.

6.3 Duration to the First Output after Installation:

Immediately after installation and commissioning of the treatment unit.

6.4 Is the Product Output Seasonal or Continuous:

The Nalgonda technique produces continuous output.

6.5 Quality and Stability of the Obtained Product:

The treated water meets various National and International guidelines/regulatory requirements.

6.6 Economic Unit Size:

The size of the plant will be determined by the treated water requirement and the size of the village.

6.7 Indicative Investment:

Depend upon the size of the plant

7.8 Status of Commercialization of the Technology:

7. Technology photos (Field installations)



Fill & Draw Defluoridation Demonstration Plants Installed by NEERI
Full Scale Plant , 2.27 MLD, Installed at Kadiri (AP)



Fill-and-draw Defluoridation Plant at Badarpur, Gujarat



For queries, please write to :

Director,

CSIR-National Environmental Engineering Research Institute
(CSIR-NEERI), Nehru Marg, Nagpur-440020, Maharashtra, India



+91-712-2249999



+91-712-2249900



director.neeri@csir.res.in

Dr. Atul Maldhure,
Dr. G. K. Khadse,
Dr. Paras Ranjan Pujari,
WRG, CSIR-NEERI



<http://www.neeri.res.in>
atul.maldhure@csir.res.in,
gajanan.khadse@csir.res.in,
paras.pujari@csir.res.in



TRL

9

IN-SITU TREATMENT OF FLUORIDE IN A HARD ROCK SETTING BY MANAGED AQUIFER RECHARGE

TRL 9

CSIR-National Environmental Engineering Research Institute
(CSIR-NEERI), Nagpur - 440020, Maharashtra, India

1. Name of CSIR Laboratory

CSIR-National Environmental Engineering Research Institute (CSIR-NEERI), Nagpur - 440 020, Maharashtra, India.

2. Name of Technology

In-situ treatment of fluoride in a hard rock setting by Managed Aquifer Recharge.

3. TRL Level: 9

TRL 9 -This technology/intervention is implemented in a school in the village Shivilal Dhana, District Chhindwara, Madhya Pradesh.

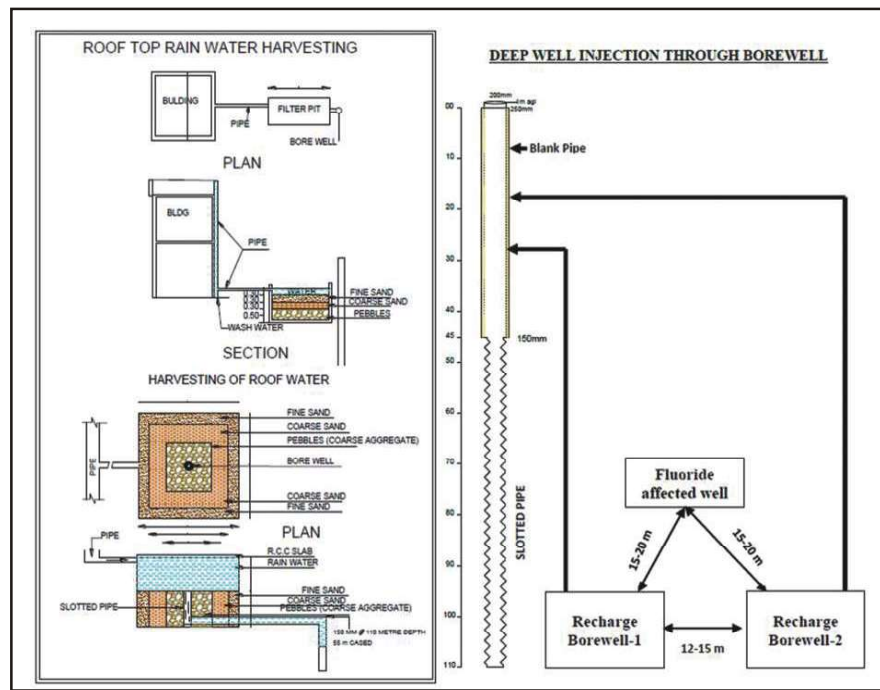

4. Preamble

The impact of recharge on fluoride concentration can be very complex, and in-situ treatment may not always lead to dilution. The mitigation of elevated fluoride concentrations through the artificial recharge method (also known as Managed Aquifer Recharge) depends on the genesis of these concentrations in the hydrogeological setting. Successful implementation requires extensive hydrogeological data collection, which should lead to the selection of the most appropriate recharge method for the site-specific hydrogeological conditions.

The main objective of the technology is -

- In-situ dilution of fluoride using artificial groundwater recharge
- Demonstrate the potential of artificial groundwater recharge in fluoride dilution at large (community scale), in addition to addressing the water scarcity issue
- Determine the efficacy of artificial recharge structures in a fluoride-affected watershed in central India

Its cost-intensive intervention and rain(roof)water harvesting and recharge structure may cost around Rs 25-30 (indicative).

5. Technical Description

The technology seeks to dilute the fluoride concentration in groundwater when the source is the deeper aquifer. The Technology can be deployed when the pre-monsoon groundwater level is 10-15 m (below ground level). Harvested rainwater can be collected and injected into the deeper aquifer through injection wells, with blank pipe provided up to the interface between the top and deeper aquifers. The pipe in the deeper aquifer is to allow the recharge water to spread and dilute the fluoride concentration.

6. Design Details

6.1 Salient Features

- The technology is aimed at in-situ dilution of fluoride in groundwater via deep-well injection. It involves collecting rooftop rainwater, followed by injection into the deeper aquifer (with elevated fluoride) through injection wells. It has the advantages of the pump-and-treat treatment: it does not require energy for pumping, and O & M costs are very low because it does not require the regular deployment of manpower. The technology can be deployed at sites where sufficient rooftop area is available to collect rainwater and the aquifer has a desaturated volume to accommodate the recharge. It is suitable for areas without surface water supply.

6.2 Equipment and Machinery Required for Deployment:

- A suitable rooftop area should be available near the fluoride-affected groundwater source (Hand pump/Bore well) to collect rainwater. It is also necessary that the aquifer have sufficient desaturation with the groundwater level, at 10-15 m (below ground level) or deeper, to make the aquifer amenable to recharge. Recharge wells (nos. may vary) and recharge pits are designed based on the amount of rainfall at the site. The recharge pit capacity is designed to accommodate the peak intensity rainfall of 15 minutes.

6.3 Duration to the First Output after Installation:

Immediately after installation.

6.4 Is the Product Output Seasonal or Continuous:

The system will work continuously.

6.5 Quality and Stability of the Obtained Product:

Proper maintenance should be carried out before the monsoon season, including cleaning the rooftop and recharge shafts.

6.6 Market Demand of the Product:

The technology is suited to areas with no surface water supply and a deeper aquifer with a fluoride problem.

6.7 Resource Required (Raw Material, Energy, Water etc.) for Operationalization of the Technology:

PVC pipes will be required for collecting rooftop rainwater and for the design of the recharge pits. Sand and gravels are needed for the recharge pit. Cement work is also required. There is no energy requirement. The area should have normal rainfall (700-800mm or more).

6.8 Climatic and Geographical Conditions Required (Temperature, Rainfall, Humidity, Wind, Train, Soil Condition):

The technology is best suited to areas with normal rainfall, so that sufficient rooftop rainwater is collected. The technology is best suited when soil infiltration is low to very low and adequate space is unavailable at the site.

6.9 Area Footprint of the Process:

It is site specific.

6.10 Gestation Period of the Project:

2 years (includes the scientific data collection).

6.11 Economic Unit Size:

Site specific.

6.12 Indicative Investment:

Site specific (30 lakhs or more). It includes the installation of a rainwater harvesting system and the construction of recharge wells and recharge pits.

6.13 Status of Commercialization of the Technology:

It was deployed at Shivilaldhna village in Chindwada district, Madhya Pradesh.



For queries, please write to :

Director,

CSIR-National Environmental Engineering Research Institute (CSIR-NEERI),
Nehru Marg, Nagpur-440020, Maharashtra, India



+91-712-2249999



+91-712-2249900



director.neeri@csir.res.in
Dr. Paras Ranjan Pujari,
WRG, CSIR-NEERI



paras.pujari@csir.res.in

SECTION II

ARSENIC REMOVAL TECHNOLOGIES



**CERAMIC MEMBRANE BASED TECHNOLOGY FOR
REMOVAL OF ARSENIC (INCLUDING THE PROCESS
FOR MEDIA PREPARATION) AND IRON FROM GROUND
WATER**

TRL 9



**CSIR-Central Glass & Ceramic Research Institute
(CSIR-CGCRI), Kolkata 700 032, West Bengal, India**

1. Name of CSIR Laboratory:

CSIR-Central Glass & Ceramic Research Institute (CSIR-CGCRI), Kolkata 700 032, West Bengal, India.

2. Name of Technology:

Ceramic Membrane based technology for removal of arsenic (including the process for media preparation) and iron from ground water.

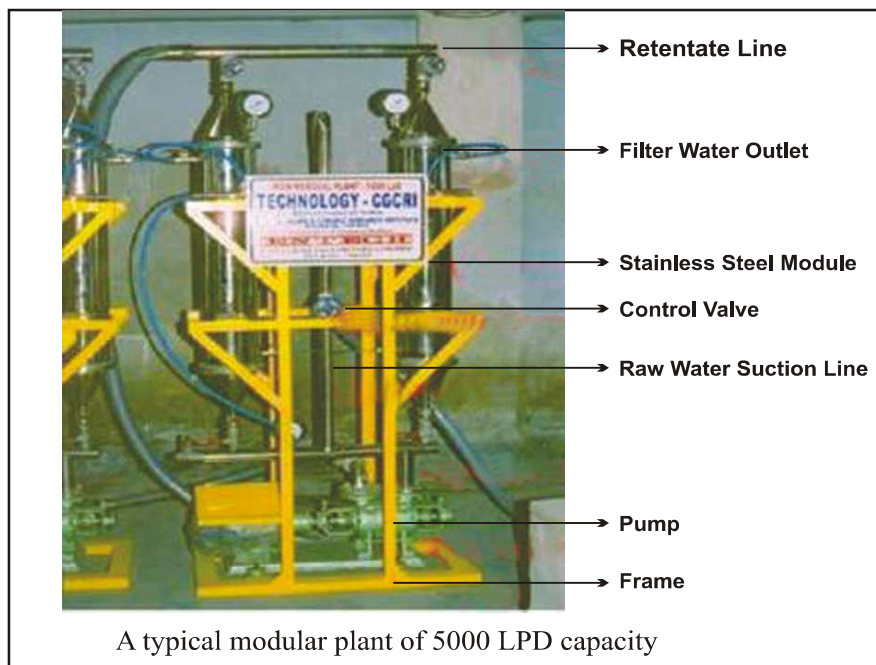
3. TRL Level: 9**4. Preamble**

In USA, under EPA's technology demonstration programme, 39 locations were chosen for technology demonstration. Out of 39 plants, 22 were based on Adsorptive media, 7 were for removal of Arsenic by Iron removal, 2 were for adsorptive media with Iron removal, 4, were based on coagulation-filtration and 2 were based on Iron exchange. The demonstration plants used mostly packed bed tanks/columns filled with media and the inlet arsenic concentration was relatively low (average 50 microgram/litre). Higher capacity plants installed with huge capital cost using adsorption techniques have been tried under field condition under this programme but their use is restricted to lower as level with reduced iron content and the limit of 10 microgram per litre could be achieved after a prolonged operation.

The present focus on arsenic remediation in third-world countries is on using iron containing compounds because they are both cheap and effective. Absorbents are not as effective in the field because of the presence of Mg^{2+} and Ca^{2+} and other naturally occurring ions, which compete with arsenic for adsorbent sites. arsenic removal technologies indicate that iron filings, ferric salts, granular ferric hydroxide, alumina manganese oxide, lanthanum hydroxide, Aqua-bind, and

Kimberlite tailings are potentially low-cost sorbents that can remove arsenic after simple mixing in a relatively short time. Fixed column of sorbents that can remove arsenic simply by-passing groundwater through the column but are ineffective when Iron is present in groundwater. Many synthetic adsorbents are available in the market which is very effective but the high cost of adsorbent is a limiting factor for use of such adsorbents. Naturally occurring solids also remove arsenic well, but the removal rate is often very slow and the product water contains bacteria.

5. Technical Description

The novelty of the CSIR-CGCRI process is deployment of a hybrid process comprised of two steps: adsorption of arsenic by the colloidal media particles suspended in water and application of membrane-based separation technique for solid-liquid separation using ceramic micro-filtration membrane modules. The efficiency of removal is higher due to intimate contact of arsenic species with colloidal adsorbent media followed by complete separation of fine particulates of iron and media by membrane through cross-flow microfiltration process. CSIR-CGCRI technologies use colloidal adsorbent media where as other technologies use granular media loaded in packed bed. Use of colloidal media is a very novel idea which results into a much better adsorption of arsenic particles; hence the level of purification achieved is also higher compared to other processes. In case of presence of iron only (absence of arsenic), colloidal media is not required.

Besides that, ease of operation and maintenance particularly electrically operated semi- automatic plant with minimum human intervention, ease of periodical cleaning (once in 3-6 months) of the modules, back washing with minimum amount of filtered water, no loss of water, smaller space requirement for plant installation, lower sludge volume, etc. make this process ideal for rural area. Typical community level or small plants are generally made of Food grade Stainless Steel with SS piping, valves, SS impeller for pump and Food grade PVC storage tanks. The use of Stainless steel makes these plants costly and capacity enhancement of the same system was not wise as due to higher price of the Stainless steel. Higher capacity plants are developed using the innovative idea of using PVC modules and piping and also MS modules which has brought down the cost of the plant.

6. Design Details

Ceramic Membrane based technology for removal of Arsenic (including the process for media preparation) and Iron from ground water.

6.1 Salient Features

- Simultaneous removal of arsenic and iron from highly contaminated ground water for producing sparkling quality drinking water (with arsenic content below the WHO recommended limit ($As < 0.01$ ppm) and negligible iron content ($Fe < 0.1$ ppm)).
- Excellent adsorption capacity of the media (7-8 times higher than normally used granular Ferric Hydroxide).
- Modular design with flexible production capacity (500-20000 LPD, 12 hours operation a day).
- Semi-automatic, user-friendly operating procedure can be operated by even the female members of the community.

- One-time media addition in 3-6 months is sufficient for 0.5-1 ppm arsenic content in raw water and continuous addition of chemicals or media regeneration is not required.
- Scope of supplying quality drinking water at a much lower cost (Rs.2/- for 5 litre and Rs. 20/- for 20 litre).
- Low sludge volume.

6.2 Equipment and machinery required for deployment

- Membrane module made of PVC/SS to accommodate ceramic 19 channel membranes of 34mm ID/1 m L, number of membranes would be based on the requirement.
- Centripetal Single-Phase Recirculation pump (2to4HP capacity)
- Feed tank and permeate tank, may be of PVC.
- Auto/Manual Back wash system comprises of a Compressor and corresponding pipings.

6.3 Duration to the first output after installation

One day

6.4 Is the product output seasonal or continuous?

Continuous

6.5 Quality and stability of the obtained product

Potable water, free of Arsenic, Iron (Within permissible Limit) and Bacteria.

6.6 Market demand of the product

Bottled and jarred drinking water has got huge consumption market.

6.7 Resource required (Raw material, energy, water etc.) for operationali-zation of the technology

The basic raw materials for the process are alumina and clay for preparation of the ceramic membranes. Stainless Steel or FRP based PVC for housing fabrication with corresponding valves and fittings.

6.8 Climatic and geographical conditions required (Temperature, rainfall, humidity, wind, train, soil condition)

Requires groundwater at source.

6.9 Area footprint of the process

25 feet by 25 feet

6.10 Gestation period of the project

One Month maximum

6.11 Economic unit size

250 LPH capacity to 10000 LPH capacity

6.12 Indicative Investment

Rs. 7-8 Lakhs of minimum economic size

6.13. Status of commercialization of the technology

Commercialized, licensed to M/s Entech Metals Pvt. Ltd. on 23/04/03 and again licensed to the same

company on 22/07/13, M/s Porel Dass Water & Effluent Control Pvt. Ltd. on 24.05.2015 & to M/s Victor Engineering on 07/09/2015, to Zeolite (India) Pvt. Ltd. on 11.9.2017, to Rollabss Hi Tech Industries, on 27.03.2018.



For queries, please write to :

Head,

Business development and publication division
196, Raja S.C. Mullick Road, Kolkata – 700 032, West Bengal, India



+91 33 23223544 / 24838079
(3544-Extension)



pmd@cgcri.res.in



director.cgcri@csir.res.in



<http://www.cgcri.res.in>



**CERAMIC MEMBRANE BASED HIGH CAPACITY
MODULES FOR: (A) PRETREATMENT OF TURBID
WATER FOR POLISHING OF IRON & ARSENIC
CONTAMINATED WATER USING MICRO FILTRATION
TECHNIQUE AND (B) PRETREATMENT OF RIVER
WATER FOR TURBIDITY AND SUSPENDED
PARTICULATE REMOVAL**

TRL 9



**CSIR-Central Glass & Ceramic Research Institute
(CSIR-CGCRI), Kolkata 700 032, West Bengal, India**

1. Name of CSIR Laboratory:

CSIR-Central Glass & Ceramic Research Institute (CSIR-CGCRI), Kolkata 700 032, West Bengal, India.

2. Name of Technology:

Ceramic membrane based high capacity modules for: (A) pretreatment of turbid water for polishing of iron & arsenic contaminated water using micro filtration technique, and (B) pretreatment of river water for turbidity and suspended particulate removal.

3. TRL Level: 9**4. Preamble**

Removal of suspended and colloidal particulate matter from River water for application as pretreatment and final polishing stages, such as Reverse Osmosis. Also used for Iron and Arsenic removal. Can be used for other surface water treatment, such as ponds and Lakes.

(Visit <https://nirbase.anusandhan.net/>).

5. Technical Description

- Complete Technology package up to 100000 LPD for commercial exploitation.

6. Design Details**6.1 Salient Features**

- a) Scaled up capacity of modules.
- b) Plant capacity up to 1 Lakh Litre per day, 12 Hrs of operation a day

- c) Modular design in battery array
- d) Semi-automatic, user-friendly operating procedure.
- e) Can be integrated with a Reverse Osmosis system.
- f) Scope of supplying quality drinking water at a much lower cost (Rs2/- or 5 litres and Rs. 20/- for 20 litres).

6.2 Equipment and Machinery Required for Deployment:

- Membrane module made of MS to accommodate ceramic 19-channel membranes of 34mm ID/1 m L, 55 membranes.
- Centrifugal 3 Phase Recirculation Pump (up to 15 HP capacity)
- River water settling tank
- Feed tank and permeate tank may be of PVC
- The Auto/Manual Backwash system comprises a Compressor and the corresponding piping.

6.3 Quality and Stability of the Obtained Product:

- Complete Technology package up to the capacity of 10m³ per hour.

6.4 Resource Required (Raw Material, Energy, Water etc.) for Operationalization of the Technology:

- The basic raw materials for the process are alumina and clay for preparation of the ceramic membranes.
- Epoxy coated MS module (2000 LPH capacity each) for housing fabrication with corresponding valves and fittings.

6.5 Economic Unit Size:

- Techno economic feasibility primarily established through two Installation.

6.6 Status of Commercialization of the Technology:

- Not patented
- Technology licensed to M/s Porel Dass Water & Effluent Control Pvt. Ltd. on 11.05.2011 and to Sarvo Technologies Limited, Faridabad on 30.8.2017.

7. Technology photos (Field installations)





Settled River Water

Ceramic Membrane
Filter Water**For queries, please write to :****Head,**

Business development and publication division

196, Raja S.C. Mullick Road, Kolkata – 700 032, West Bengal, India

**+91 33 23223544 / 24838079**
(3544-Extension)**pmd@cgcri.res.in****director.cgcri@csir.res.in****<http://www.cgcri.res.in>**

TRL

7



HIGH FLOW RATE ARSENIC REMOVAL FILTER

TRL 7

CSIR- Central Mechanical Engineering Research Institute
(CSIR-CMERI), M.G. Avenue, Durgapur 713 209,
West Bengal, India

1. **Name of CSIR Laboratory**
CSIR Central Mechanical Engineering Research Institute (CSIR-CMERI),
M.G.Avenue, Durgapur 713209, West Bengal, India.
2. **Name of Technology**
High Flow Rate Arsenic Removal Filter.
3. **TRL Level: 7**



High Flow Rate Arsenic Removal Filter at CSIR-CMERI

4. Preamble

Arsenic is naturally present at high concentrations in the groundwater of several countries. Due to its high toxicity in inorganic form, contaminated water used for drinking and irrigation of crops poses the greatest threat to public health from arsenic. Long-term exposure to arsenic-rich water can cause various adverse health effects, including skin problems and cancers. Thus, natural arsenic contamination is a significant concern in many countries of the world, including India, Bangladesh, Thailand, China, Argentina, Chile, Mexico, and the US. The US Environmental Protection Agency (EPA) and the World Health Organization have set the maximum permissible level of arsenic in drinking water at 10 parts per billion (ppb). Since arsenic concentrations frequently exceed this level, there is an urgent need for new and efficient techniques to economically and effectively remove arsenic from ground water.

5. Technical Description

CSIR-CMERI has developed a new filtering process to remove arsenic from contaminated ground as well as surface water with high flow rate capacity. The new water purification process designed

here follows four essential stages, such as (i) oxidation of arsenic [As(III)] by the aerial oxygen/chlorine solution and MnO₂ chips in the first chamber (vessel 1); (ii) precipitation of the arsenic loaded iron particles by the sand layer in the second chamber (vessel 2); (iii) complexation of the residual arsenic by the rice husk/coconut husk activated carbon in third chamber (vessel 3) and (iv) finally, activation process of filtered water in the fourth vessel (vessel 4). The fabricated plant is capable of filtering arsenic-contaminated water with a flow rate of about 4,500-5,000 LPH. The removal plant has backwashing capabilities to regenerate the media for filtering multiple times. The filtering plant is useful for the removal of arsenic from groundwater, which may contain arsenic at concentrations of ≥ 0.3 ppm to close to the WHO limit (~ 0.01 ppm). Besides arsenic removal, the filter plant has the capabilities to reduce bacterial contamination from the water.

6. Design Details

6.1 Salient Features

TECHNICAL SPECIFICATIONS	
Model	High Flow Rate Arsenic Removal Filter
Filterable water with maximum arsenic concentration	≥ 0.3 ppm
Purification	4-stage (coagulation, oxidation, precipitation, filtration & activation)
Filtering Media	Pebbles, manganese oxide, chlorine source, sand, anthracite and activated carbon: reusable media after back wash
Filtering Capacity	22,000-25,000 L/Day
Flow Rate	4500-5000 LPH
Electricity Consumption	Electric operated pump to induce high-flow rate

6.2 Equipment and Machinery Required for Deployment:

- Power supply, shed and cement foundation, drain line and sludge disposal system.

6.3 Duration to the First Output after Installation:

2 h after initial cleaning of the filter media.

6.4 Is the Product Output Seasonal or Continuous:

Continuous.

6.5 Quality and Stability of the Obtained Product:

The High Flow Rate Arsenic Removal Filter is a stable product and the quality of filtered water (Arsenic ~ 0.01 ppm, close to WHO limit) has been checked through NABL Accredited Laboratory.

6.6 Market Demand of the Product:

The present high flow rate arsenic purification plant is mainly targeted to the population of over

500 million in world including Ganga-Meghna-Brahmaputra delta regions of India where there is no access to arsenic free safe drinking water. The available arsenic purifiers do not have complete capabilities to remove arsenic at affordable cost, which posed a serious threat to the human society. Thus, there is plenty of opportunity with this purification device to come up as a commercial product in India, Bangladesh and other developing countries that can compete with high-end water treatment products to remove arsenic contaminants along with bacteria from drinking water.

6.7 Resource Required (Raw Material, Energy, Water etc.) for Operationalization of the Technology:

For media:

Pebbles: Water Filter Pebbles (2-5 mm, 5-8 mm, 12-20 mm)

Fine sand: Water filter sand (50 mesh)

Graded Sand: Water Filter Sand (1-2 mm)

Anthracite: Anthracite media

Coconut shell based activated carbon/rise husk based activated carbon

Activated carbon: Activated carbon for filter media

Manganese oxide: Oxidation media (19 mm x 12 mm)

Chlorine source (Bleaching powder/sodium hypochlorite solution)

For Filter Body

Plastic container: PVC grade

FRP vessel upto 10 bar (14"×65")

FRP vessel upto 10 bar (24"×72")

Multiport Valves (dia 40mm)

PVC pipe fittings (dia 40 mm) and instrumentation

Feed / backwash pump: Minimum of 2 HP pump with flow rate 8000 LPH

Rotameter upto 10000 L

Water flow meter (dia 40 mm).

6.8 Climatic and Geographical Conditions Required (Temperature, Rainfall, Humidity, Wind, Train, Soil Condition):

Suitable Indian climatic condition.

6.9 Area Footprint of the Process:

Community Water Supply System; Footprint: 5-6 m².

6.10 Gestation Period of the Project:

3 months.

6.11 Economic Unit Size:

- Optimal economic size: 72-100 m³/day
- Corresponding flow rate: ~4.55.0 m³/h
- Target users: 3,000-5,000 persons (drinking + cooking water).

6.12 Indicative Investment:

Rs. 2.3 lakh.

6.13 Status of Commercialization of the Technology:

Technology has been transferred to 5 nos. MSME with each transfer amount of Rs.7.50 Lakhs (including GST).

7. Technology photos (Field installations)

Technology transfer to MSMEs



For queries, please write to :

Head,

Business Development Unit, CSIR-Central Mechanical Engineering Research Institute (CSIR-CMERI), M.G. Avenue, Durgapur – 713209, West Bengal, India



0343-6510237



director.cmeri@csir.res.in
bdg.cmeri@csir.res.in



<http://www.cmeri.res.in>



TRL
7

COMMUNITY LEVEL ARSENIC REMOVAL PLANT (MODEL-I)

TRL 7

**CSIR- Central Mechanical Engineering Research Institute
(CSIR-CMERI),
M.G. Avenue, Durgapur 713209, West Bengal, India**

1. Name of CSIR Laboratory

CSIR Central Mechanical Engineering Research Institute (CSIR-CMERI),
M.G. Avenue, Durgapur 713209, West Bengal, India.

2. Name of Technology

Community level Arsenic Removal Plant (Model-I).

3. TRL Level : 7**4. Preamble**

Arsenic (As) contamination in ground water and related health hazards are more disastrous than any other natural calamity throughout the world in the last two decades. Drinking arsenic-rich water over a long period impacts health in various ways, including skin problems skin cancer, cancers of the bladder, kidney and lung, and diseases of the blood vessels of the legs and feet, and possibly also diabetes, high blood pressure and reproductive disorders. To solve this problem, CSIR-CMERI, Durgapur has developed community level arsenic removal Plant-Model-I.

5. Technical Description

CSIR-CMERI, Durgapur has developed community level arsenic removal Plant-Model-I which is a chemical free, electrical power free and completely a green technology base solution for removal of arsenic from groundwater.

6. Design Details

6.1 Salient Features

- Capacity: 700 L/hr. (approx.) [attachable to Submersible pump and Mark-II hand pump]
- Geo-materials (media based adsorbent) used for removal
- No electric power requirement
- No running cost
- Instant arsenic free water.

6.2 Equipment and Machinery Required for Deployment:

- Sheet bending machine, welding, grinder etc.

6.3 Duration to the First Output after Installation:

Instantaneous.

6.4 Is the Product Output Seasonal or Continuous:

Continuous.

6.5 Quality and Stability of the Obtained Product:

Satisfy Indian Standard Code guidelines.

6.6 Market Demand of the Product:

Vast.

6.7 Resource Required (Raw Material, Energy, Water etc.) for Operationalization of the Technology:

Arsenic contaminated underground water.

6.8 Climatic and Geographical Conditions Required (Temperature, Rainfall, Humidity, Wind, Train, Soil Condition):

Functionality do not depend on climatic and geographical conditions.

6.9 Area Footprint of the Process:

1.0m x 1.0m.

6.10 Gestation Period of the Project:

06 months.

6.11 Economic Unit Size:

Manufacturing cost (MS made): Rs. 40,000/- (approx.) [installation, filter media & transportation charges extra].

6.12 Indicative Investment:

Rs. 2.5 Lakh.

6.13 Status of Commercialization of the Technology:

Ready for commercialization. Technology has been transferred to one Indian Industry.

**For queries, please write to :****Head,**

Business Development Unit, CSIR-Central Mechanical Engineering Research Institute
(CSIR-CMERI), M.G. Avenue, Durgapur – 713209, West Bengal, India



0343-6510237



director.cmeri@csir.res.in
bdg.cmeri@csir.res.in



<http://www.cmeri.res.in>



TRL

7

COMMUNITY LEVEL ARSENIC REMOVAL FILTER - MODEL II

TRL 7

**CSIR- Central Mechanical Engineering Research Institute
(CSIR-CMERI),
M.G. Avenue, Durgapur 713209, West Bengal, India**

1. Name of CSIR Laboratory

CSIR - Central Mechanical Engineering Research Institute (CSIR-CMERI), M.G. Avenue, Durgapur 713209, West Bengal, India.

2. Name of Technology

Community Level Arsenic Removal Filter-Model II

3. TRL Level: 7

Community Level Arsenic Removal Filter-Model II at CSIR-CMERI

4. Preamble

Natural arsenic contamination is a major concern these days in the world including Ganga-Meghna-Brahmaputra delta regions of India. Nine districts in West Bengal itself have an arsenic level in groundwater above the maximum permissible limit of 50 mg/l (50 ppm). Due to its high toxicity in inorganic form, contaminated water used for drinking and irrigation of crops poses the greatest threat to public health from arsenic. Long-term exposure to arsenic-rich water can cause various adverse health effects, including skin problems and cancers. The US Environmental Protection Agency (EPA) and the World Health Organization have set the maximum permissible level of arsenic in drinking water at 10 parts per billion (ppb). Since arsenic concentrations frequently exceed this level, there is an urgent need for new and efficient techniques to economically and effectively remove arsenic from ground water.

5. Technical Description

CSIR-CMERI has developed a community level arsenic water filter using 1500 L tank in which 18 cartridges are attached to the bottom-middle of the upper chamber (volume ~800 liters). The chamber along with the cartridge is placed over a lower chamber (volume ~700 liters). An outlet is attached at the bottom of the lower chamber. Both the chambers of the filter are made of mild-steel. Fiber-Reinforced plastic tank is connected in to the upper tank that acts as a pre-filtration unit. The filtering cartridge is based on three-stage purification technology, where (a) a first layer of cleaned sand is used to remove larger size solid particles, (b) a second layer of mixed metal-oxides (copper oxide: iron oxide = 1:3) impregnated activated rice husk char and alumina to remove arsenic including fluoride, and bacteria, etc. (c) a third layer of cleaned stone chips further used to stop leaching of chemicals and nanoparticles into purified water. All the adsorbents are placed stage-wise in a container, which acts as cartridge of the arsenic removal plant. This plant is useful for removal of arsenic from ground water which may contain arsenic of 0.01 0.50 ppm to bellow WHO limit (<10 ppb). The plant can filter ~40000 liters of the contaminated water with a flow rate ~400 liters/hour before replacing the cartridge.

6. Design Details

6.1 Salient Features

TECHNICAL SPECIFICATIONS	
Model	Community Level Arsenic water filter
Water storage capacity	1500 L
Filtering capacity	40000 L per cycle
Cartridge	18 nos, replaceable
Purification	3-stage
Flow rate	350-400 L/Hour
Electricity consumption	Power free

6.2 Equipment and Machinery Required for Deployment:

- Shed and cement foundation, drain line and sludge disposal system.

6.3 Duration to the First Output after Installation:

2 h after initial cleaning of the filter media.

6.4 Is the Product Output Seasonal or Continuous:

Continuous.

6.5 Quality and Stability of the Obtained Product:

The Community Level Arsenic Removal Filter Model II demonstrates high product quality (Arsenic ~0.01 ppm, close to WHO limit) and operational stability, combining power-free operation, and robust arsenic removal performance checked through NABL Accredited Laboratory.

6.6 Market Demand of the Product:

The Community Level Arsenic Removal Filter - Model II developed by CSIR-CMERI has

substantial market demand across local, national, and global levels, driven by the widespread prevalence of arsenic contamination in groundwater and increasing demand for decentralized, sustainable water purification technologies.

6.7 Resource Required (Raw Material, Energy, Water etc.) for Operationalization of the Technology:

For Cartridge:

Alumina: Granules Alumina Balls

FeCl₃: Powder Ferric Chloride, Grade Standard: Reagent Grade, for Laboratory

CuCl₂: Powder

NaOH: Sodium Hydroxide Pellets

Rice husk: Natural Rice Husk

Sand: Filter Sand

Glossy White Stone Chips

Plastic container: PVC grade

For Filter body:

Mild steel

6.8 Climatic and Geographical Conditions Required (Temperature, Rainfall, Humidity, Wind, Train, Soil Condition):

Suitable Indian climatic condition.

6.9 Area Footprint of the Process:

Estimated total ground space required (including access clearance): ~2.5-3.0 m² (allows for cartridge replacement, routine inspection, and safe user access).

6.10 Gestation Period of the Project:

3 months.

6.11 Economic Unit Size:

Optimal economic size: Flow rate of 350-400 L/hour enables daily production of approximately 2,800-3,200 L assuming 8 hours of operation.

6.12 Indicative Investment:

Rs. 1.2 Lakh.

6.13 Status of Commercialization of the Technology:

Technology transfer to 5 nos. MSMEs.



For queries, please write to :

Head,

Business Development Unit, CSIR-Central Mechanical Engineering Research Institute (CSIR-CMERI), M.G. Avenue, Durgapur – 713209, West Bengal, India



0343-6510237



director.cmeri@csir.res.in
bdg.cmeri@csir.res.in



<http://www.cmeri.res.in>

**PROCESS BASED ON POLYMER-BASED
ION-EXCHANGE RESINS FOR THE REMOVAL OF
ARSENIC FROM GROUNDWATER
AND ARSENIC DETECTING KIT**

TRL 7



**CSIR-Central Salt and Marine Chemical Research Institute
(CSIR-CSMCRI), Bhavnagar-364 002, Gujarat, India**

1. Name of CSIR Laboratory:

CSIR-Central Salt and Marine Chemical Research Institute (CSIR-CSMCRI), Bhavnagar - 364 002, Gujarat.

2. Name of Technology:

Process based on polymer-based ion-exchange resins for the removal of arsenic from groundwater and arsenic detecting kit.

3. TRL Level: 7

- Functionalization of resin can be achieved at 20 kg/batch in a 100 litre RBF equipped with a heating and cooling assembly.
- 65 domestic and 12 community-scale units with capacities of 25 LPH and 250 LPH, respectively, were deployed in arsenic-affected rural areas of 24-Parganas (N), West Bengal, to provide arsenic-free water.
- Test kits were also supplied, along with a plant, to analyse field water samples.

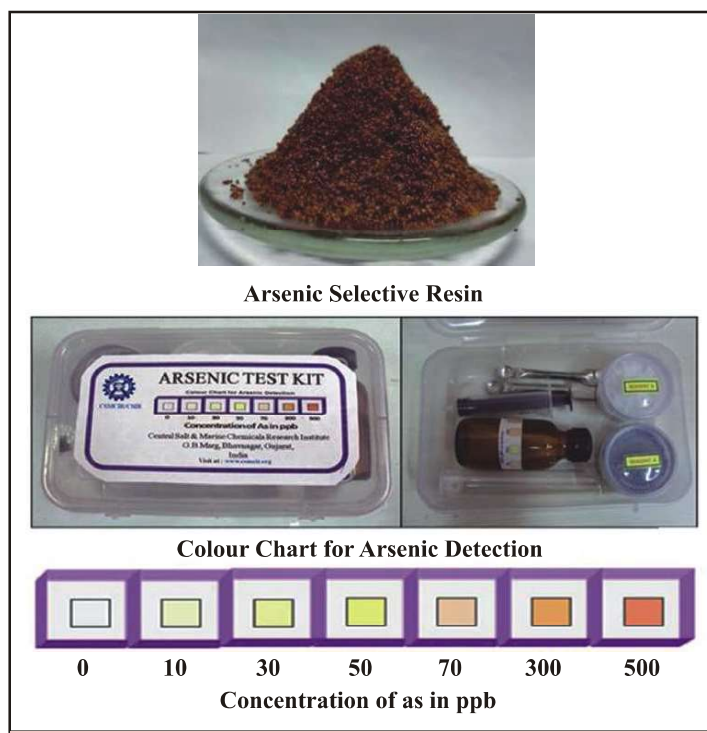
**4. Preamble**

- Resin: Removal of arsenic from water.
- Arsenic detecting kit: A test kit to detect arsenic semi-quantitatively in groundwater up to 10ppb.

5. Technical Description

- Resin preparation and arsenic test kit making depend on the scale of manufacturing.
- Will be available on request.

6. Design Details

6.1 Salient Features

1. Ion exchange resin technology for the removal of arsenic from groundwater.
 - No electricity required
 - No skill is required to operate.
 - The resin developed efficiently removes both forms of arsenic present in the water.
 - Reusable after regeneration.
 - Easily separable after use.
2. Economical and easy to use arsenic detection test kits to analyse the presence of arsenic in water.
 - Colorimetric detection of arsenic in water.
 - Have a shelf-life of ~2 years.
3. The process is quite economical, field-tested and also clean in a true sense.

6.2 Equipment and Machinery Required for Deployment:

- Resin Plant: Pumps, fittings, column, Overhead tanks, receiver tank, etc.
- Test Kit: Glass bottle with lid, brown bottle to keep test strips.

6.3 Market Demand of the Product:

- The technology is ready for technology transfer and can be implemented on commercial scale. The product has high demand in water purification for arsenic-free water.
- The test kits are easy to use to analyse the presence of arsenic in water.

6.4 Resource Required (Raw Material, Energy, Water etc.) for Operationalization of the Technology:

- Resin: Monomers like methyl methacrylate, methacrylic acid, ethyleneglycol dimethacrylate, divinyl benzene, aliphatic amines, ferric chloride, hydrochloric acid and caustic alkali, etc.
- Test Kit: Whatman filter paper, mercuric bromide, rosoline, nitric acid, ethanol, PVA, sulphamic acid, zinc metal dust, etc.

6.5 Economic Unit Size:

- Depends on the scale of manufacturing, it will be available on request.

6.6 Status of Commercialization of the Technology:

- IN 287502.
- Ready for the licensing.



For queries, please write to :

Head,

Business Development & Information Management CSIR-Central Salt and Marine Chemical Research Institute (CSIR-CSMCRI), Bhavnagar – 364 002, Gujarat



0278-2567462,
Extn. No.: 7800



kamlesh.csmcri@csir.res.in
bdim.csmcri@csir.res.in



director.csmcri@csir.res.in



<http://www.csmcri.res.in>



**PREPARATION OF SPECIFIC POLYMERIC ADSORBENTS
FOR THE REMOVAL OF ARSENIC AND ARSENIC &
FLUORIDE FROM DRINKING WATER**

TRL 4

**CSIR-Central Salt and Marine Chemical Research Institute
(CSIR-CSMCRI), Bhavnagar-364 002, Gujarat, India**

1. Name of CSIR Laboratory:

CSIR-Central Salt and Marine Chemical Research Institute (CSIR-CSMCRI),
Bhavnagar - 364 002, Gujarat.

2. Name of Technology:

Preparation of specific polymeric adsorbents for the removal of arsenic and arsenic & fluoride from drinking water.

3. TRL Level: 4

Laboratory scale @500g/batch.

**4. Preamble**

Removal of arsenic, arsenic & fluoride from water.

5. Technical Description

Material preparation; Demonstration.

6. Design Details**6.1 Salient Features**

Polymeric adsorbent technology for the removal of arsenic and fluoride from groundwater.

- Single-step preparation
- No electricity required.
- No skill is required to operate.
- Efficiently removes fluoride and both forms of arsenic present in the water.

- Reusable after regeneration.
- Easily separable after use.
- Eco-friendly.

6.2 Equipment and Machinery Required for Deployment:

- Material preparation equipment, such as RBF reactor equipped with an overhead stirrer, heating and cooling assembly, and a temperature sensor.
- Materials for plant deployment, such as pumps, fittings, FRP columns, overhead tanks, and receiver tanks, etc.

6.3 Market Demand of the Product:

- The technology is ready for technology transfer and can be implemented on commercial scale. The product has high demand in the water sector for arsenic and fluoride removal.

6.4 Resource Required (Raw Material, Energy, Water etc.) for Operationalization of the Technology:

- Vinyl monomer, methyl methacrylate, methacrylic acid, ethylene glycol dimethacrylate, divinyl benzene, amines, ferric chloride, hydrochloric acid and caustic alkali, etc.

6.5 Economic Unit Size:

- Depending on the scale of manufacturing, it will be available on request.

6.6 Status of Commercialization of the Technology:

- IN 201711008762; IN 0053NF2019.
- Ready for licensing.



For queries, please write to :

Head,

Business Development & Information Management CSIR-Central Salt and Marine Chemical Research Institute (CSIR-CSMCRI), Bhavnagar – 364 002, Gujarat



0278-2567462,
Extn. No.: 7800



kamlesh.csmcri@csir.res.in
bdim.csmcri@csir.res.in



director.csmcri@csir.res.in



<http://www.csmcri.res.in>

SECTION III

IRON REMOVAL TECHNOLOGIES

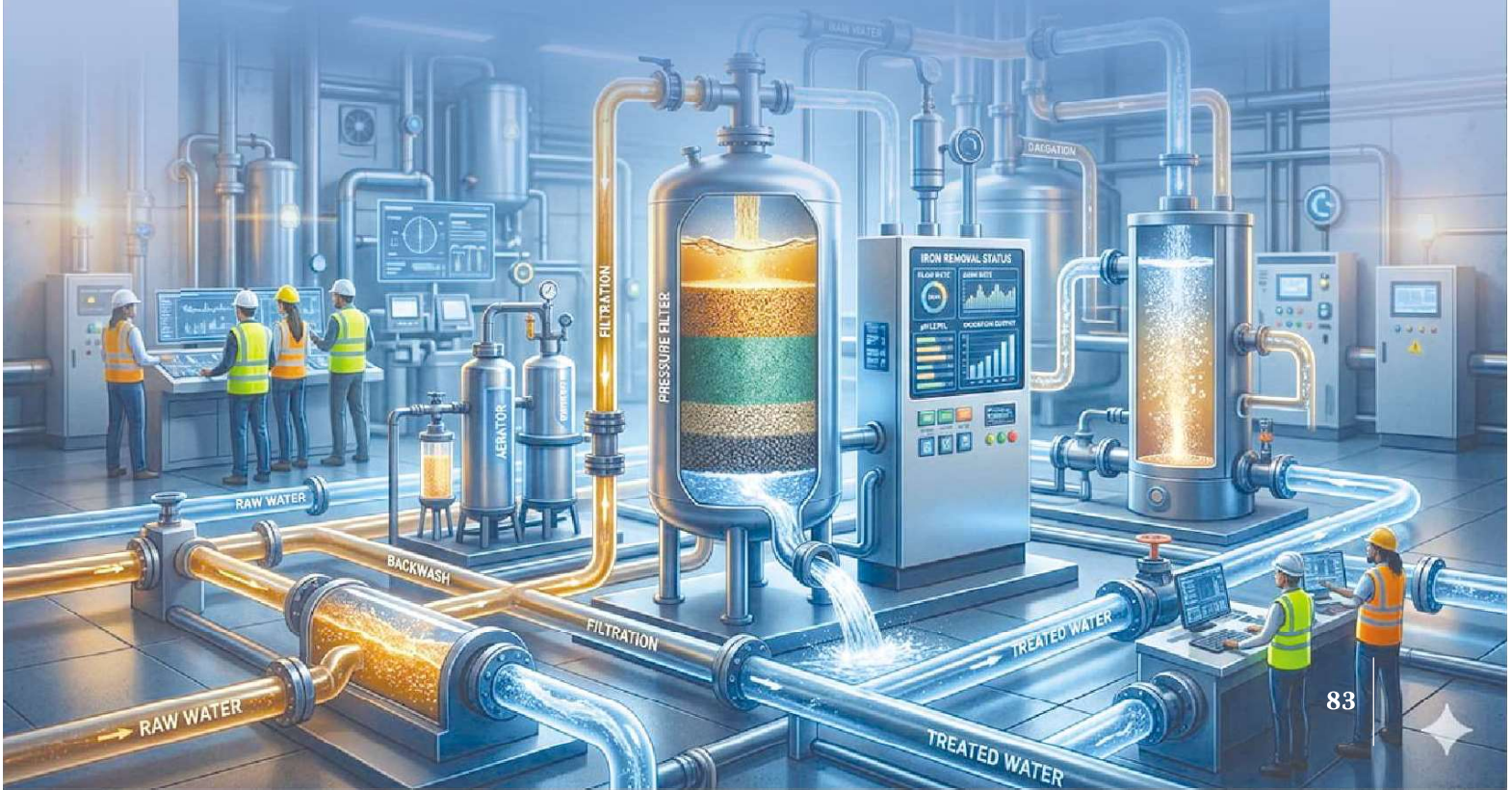

HIGH FLOW RATE IRON REMOVAL FILTER

TRL 7



CSIR- Central Mechanical Engineering Research Institute
(CSIR-CMERI), M.G. Avenue, Durgapur 713209,
West Bengal, India

1. Name of CSIR Laboratory

CSIR-Central Mechanical Engineering Research Institute (CSIR-CMERI), M.G. Avenue, Durgapur 713209, West Bengal, India.

2. Name of Technology

High Flow Rate Iron Removal Filter.

3. TRL Level: 7



High Flow Rate Iron Removal Filter at CSIR-CMERI

4. Preamble

Groundwater has been frequently found to be contaminated with iron. The presence of iron in water results in staining as well as offensive tastes and appearances. Waters containing iron, on exposure to air or oxygen, become cloudy and turbid due to the oxidation of iron to the Fe(III) state, which forms colloidal precipitates. The oxidation rates are not rapid, and reduced forms can persist for some time in groundwater. Thus, there is a clear demand for an affordable and efficient iron removal water filter, which can decontaminate Fe(II) and Fe(III) to produce iron-free clean water.

5. Technical Description

CSIR-CMERI has developed a high-flow rate iron removal filter, using two numbers of fiber reinforced plastic (FRP) vessels (volume: 165 liters each) in which the media materials are placed in a stage-wise manner. A separate plastic tank containing MnO₂ chips (size range: 3-6 mm) and a chlorine dosing tank are attached for the oxidation of Fe(II) and facilitate the iron precipitation process during filtration. The overall iron removal process is based on the 3-stage purification technology. First step, involves the oxidation of iron [Fe(II)] by chlorine followed by the MnO₂ layer in the oxidation tank; second step, consists of the precipitation of the oxidized iron on the sand layer and third step, includes the filtration as well as activation process using media materials kept in first and second FRP vessels. The FRP contains various media materials like pebbles (size range: 12-19 mm; 6-12 mm; 3-6 mm) and sand (size range: 1-2 mm). Likewise, the second vessel contains the

pebbles (size range: 18-25 mm), anthracite (size range: 3-6 mm), and activated carbon (size range: 3-6 mm). The media materials have placed bottom-to-top directions in each vessel to remove the iron as well as other insoluble contaminants. The filtering system is equipped with an electric-operated pump (0.5 HP), a flow meter, and a pressure gauge to control the input and output water flow rate. The system is capable of filtering iron-contaminated water with a flow rate of about 3,000-3,500 L/H. The filter has backwashing capabilities to regenerate the media for filtering multiple times. The filter is useful for the removal of iron from groundwater, which may contain iron at a concentration of ~12.0 ppm below the WHO limit (<0.3 ppm). The high flow rate iron removal filter may also be developed without the flow meter and pressure gauge, but with similar efficiency.

6. Design Details

6.1 Salient Features

Technical Specifications	
Model	High Flow Rate Iron Removal Filter
Filterable water with maximum iron concentration	12 ppm
Purification	3-stage (oxidation, precipitation, filtration & activation)
Filtering Media	Pebbles, manganese oxide, chlorine source, sand, anthracite and activated carbon: reusable media after back wash
Filtering Capacity	15000-17000 L/Day
Flow Rate	3000-3500 L/Hour
Electricity Consumption	Electric operated pump to induce high-flow rate

6.2 Equipment and Machinery Required for Deployment:

Power supply, shed and cement foundation, drain line and sludge disposal system.

6.3 Duration to the First Output after Installation:

2 h after initial cleaning of the filter media.

6.4 Is the Product Output Seasonal or Continuous:

Continuous.

6.5 Quality and Stability of the Obtained Product:

The high flow rate iron removal filter is a stable product and the quality of filtered water (iron ~0.3 ppm, close to WHO limit) checked through NABL Accredited Laboratory.

6.6 Market Demand of the Product:

The High Flow Rate Iron Removal Filter developed by CSIR-CMERI has substantial market demand across local, national, and global levels, driven by the widespread prevalence of iron

contamination in groundwater and increasing demand for decentralized, sustainable water purification technologies.

6.7 Resource Required (Raw Material, Energy, Water etc.) for Operationalization of the Technology:

For media:

Pebbles: Water Filter Pebbles (2-5 mm, 5-8 mm, 12-20 mm),

Sand: Water Filter Sand (1-2 mm)

Anthracite: Anthracite media

Activated carbon: Activated carbon for filter media

Manganese oxide: Granular media

Chlorine source: Chlorine dozer for water treatment

For Filter Body

Plastic container&FRP vessel: PVC grade

Valves, fittings and instrumentation

Feed / backwash pump: Minimum of 0.5 HP pump with a min. pressure of 0.5 bar.

6.8 Climatic and Geographical Conditions Required (Temperature, Rainfall, Humidity, Wind, Train, Soil Condition):

Suitable Indian climatic any geographical condition.

6.9 Area Footprint of the Process:

Estimated floor area: ~4.0-5.0 m².

6.10 Gestation Period of the Project:

5 months.

6.11 Economic Unit Size:

15,000-17,000 liters per day (LPD) per filtration unit.

6.12 Indicative Investment:

Estimated cost 0.6 Lakh.

6.13 Status of Commercialization of the Technology:

CSIR-CMERI has already transferred the technology/know-how to 20 nos. of industries/MSMEs.

7. Technology photos (Field installations)

CSIR-CMERI High Flow Rate Iron Removal Plant has been commercialized by our license (M/s M/s Mission Minimise LLP, Bihar) in “Har Ghar Nal Ka Jal” mission of Government of Bihar.

The photograph of the same is attached.



The above commercial plant has been installed in 4 districts of Bihar for removal of excess iron. The plant has attached to the submersible pump and providing iron free drinking water to the village people.



For queries, please write to :

**Head, Business Development Unit,
CSIR-Central Mechanical Engineering Research Institute
(CSIR-CMERI), M.G. Avenue, Durgapur-713209,
West Bengal, India**



0343-6510237



director.cmeri@csir.res.in
bdg.cmeri@csir.res.in



<http://www.cmeri.res.in>



DOMESTIC IRON REMOVAL FILTER

TRL 6



CSIR- Central Mechanical Engineering Research Institute
(CSIR-CMERI), M.G. Avenue, Durgapur -713209,
West Bengal, India

1. Name of CSIR Laboratory

CSIR - Central Mechanical Engineering Research Institute (CSIR-CMERI), M.G. Avenue, Durgapur 713209, West Bengal, India.

2. Name of Technology

Domestic Iron Removal Filter.

3. TRL Level: 6



4. Preamble

Ground water is an essential component of daily life support system in India, especially in the rural areas where it is the only resource of drinking water. An excess amount of iron in the ground water which can create health and economic complications. Though iron is an essential element required for the human body system but continuous consumption of water containing excess iron may lead to stomach problems, nausea, vomiting, effects on skin, etc. High iron is associated with discoloration, turbidity and taste problems, in addition to forming slime and iron accumulation in pipes. Iron also promotes the growth of certain types of chlorine-tolerant microorganisms in water distribution systems, including organisms harmful to human health and also increases the cost of cleaning and sterilizing systems. As per WHO, the upper limit of iron in drinking water is 0.3 mg/l, but there are 297 districts of 24 Indian states having underground water contaminated by excessive concentration of iron.

5. Technical Description

Domestic type filtration unit, addressing the removal of iron from groundwater is very much in demand in areas depending solely on groundwater for their livelihood.

6. Design Details

6.1 Salient Features

- Remove iron to the desired permissible limit (0.3ppm) of drinking water.
No electricity.
- No chemicals required
- No running water required.
- Completely green technology.

6.2 Equipment and Machinery Required for Deployment:

Stainless Steel Grade 316 sheet, Welding machine.

6.3 Duration to the First Output after Installation:

Instantaneous.

6.4 Is the Product Output Seasonal or Continuous:

Continuous.

6.5 Quality and Stability of the Obtained Product:

Qualify IS code and WHO requirement.

6.6 Market Demand of the Product:

Vast.

6.7 Resource Required (Raw Material, Energy, Water etc.) for Operationalization of the Technology:

Iron contaminated water.

6.8 Climatic and Geographical Conditions Required (Temperature, Rainfall, Humidity, Wind, Train, Soil Condition):

Functionality not depends on climatic and geographical conditions.

6.9 Area Footprint of the Process:

0.4m x 0.4m.

6.10 Gestation Period of the Project:

06 months.

6.11 Economic Unit Size:

Estimated cost of the iron filter unit: Rs 1000-1500 /- (approx).

6.12 Indicative Investment:

Rs. 1.0 Lakh.

6.13 Status of Commercialization of the Technology:

Ready for commercialization. Technology has been transferred to one Indian Industry.

**For queries, please write to :**

Head, Business Development Unit,
CSIR-Central Mechanical Engineering Research Institute
(CSIR-CMERI), M.G. Avenue, Durgapur-713209, West Bengal, India



0343-6510237



director.cmeri@csir.res.in
bdg.cmeri@csir.res.in



<http://www.cmeri.res.in>



COMMUNITY LEVEL IMPROVED IRON REMOVAL PLANT (IIRP)

TRL 9



CSIR- Central Mechanical Engineering Research Institute
(CSIR-CMERI), M.G. Avenue, Durgapur-713209,
West Bengal, India

1. Name of CSIR Laboratory

CSIR - Central Mechanical Engineering Research Institute (CSIR-CMERI), M.G. Avenue, Durgapur 713209, West Bengal, India.

2. Name of Technology

Community Level Improved Iron Removal Plant (IIRP).

3. TRL Level: 9



4. Preamble

The IIRP, being environment friendly and electric supply free plant, has enormous social impact especially under the rural India. As per the market point of view, it can create a source of income and can widen the opportunity for talent pooling.

6. Technical Description

The primary requirement for the operation of improved iron removal plant (IIRP) is groundwater. Mark-II hand pump is suitable for most applications. The IIRP is attached to the existing Indian Mark (IM)-11 hand pump. Manually iron contaminated pumped water from the IM-11 hand pump is fed directly to the aeration chamber (02) using water sprinkler through distribution plate (01). Force & lift type arrangement fitted with the existing Mark-II and pump for lifting the iron contaminated groundwater to the aeration chamber (02). Holes (15) are provided around the walls of IIRP aeration chamber area to facilitate maximum flow of ambient air which helps for oxidation. The aerated water thus passes through gravel beds (03) and this stage ferrous iron (Fe) converts into ferric iron (Fe). The water initially settles at the pre-settling chamber (04). The water slowly rises inside the pre-settling chamber as the pumping is continued and then fall through the down pipe (11) into the settling chamber (09) at the bottom. The down pipe (11) is fixed vertically at the centre of the plant and its lower tip is diagonally cut for free flow of water from pre-settling chamber (04) to the settling chamber (09). The water gradually rises further in the settling chamber and passes through different filter media. This water initially passes through the gravel bed (08) and

subsequently passes through charcoal bed (07) and finally sand bed. So, charcoal bed is placed in-between the gravel bed (08) and sand bed (06) is used to remove odour of water -if any. Iron free water stored at the top of sand filter bed (06). The user can instantly get iron free portable clear water (13) even without pumping for sometimes. In case of non-functioning of the plant, IM-11 hand pump water can be used for other purpose other than drinking by opening the valve (16) and this water can also be used for collection of raw water (iron contaminated) for testing purpose to know the concentration of iron of the groundwater. In this present system, pre-settling chamber is fixed at the top of the settling chamber by tightening the screws which are located at places around the section/part. So, it is easy to transport as the system can be separated.

6. Design Details

6.1 Salient Features

- Capacity: 800 L/hr. (approx.) [attachable to Mark-II hand pump and possible to attach with the submersible pump also]
- Naturally available materials used for removal
- No electric power requirement
- No chemicals requirement for removal of iron
- Maintenance: Through backwashing (facility provided)
- Materials used for removal purpose can be reuse after washing.

6.2 Equipment and Machinery Required for Deployment:

- MS sheet, GI pipe, Valve, SS net, Filter media.

6.3 Duration to the First Output after Installation:

Instantaneous after installation.

6.4 Is the Product Output Seasonal or Continuous:

Continuous when in use.

6.5 Quality and Stability of the Obtained Product:

Satisfy Indian Standard code and WHO recommendations.

6.6 Market Demand of the Product:

Huge, in rural areas where underground water is laced with iron and the only source for drinking.

6.7 Resource Required (Raw Material, Energy, Water etc.) for Operationalization of the Technology:

Iron laced underground water.

6.8 Climatic and Geographical Conditions Required (Temperature, Rainfall, Humidity, Wind, Train, Soil Condition):

The technology is workable in all climatic and geographical conditions.

6.9 Area Footprint of the Process:

1.2mt x 1.2mt.

6.10 Gestation Period of the Project:

06 months.

6.11 Economic Unit Size:

Cost of water: 03 paisa/L.

6.12 Indicative Investment:

Rs. 2.50 Lakh.

6.13 Status of Commercialization of the Technology:

The Technology has been transferred to 6 Indian Industries in non-exclusive basis.

**Technology Award-2017 for "Improved Iron Removal Plant"**

From left to right : **Dr. Girish Sahni**, DG-CSIR,

Shri Y. S. Chowdhury, Minister of State for Ministry of S & T and Earth Sciences,

Dr. Harsh Vardhan, Union Minister for S & T and Earth Sciences,

Shri Ram Nath Kovind, Hon'ble President of India

Pro. (Dr.) Harish Hirani, Director of CSIR-CMERI,

Dr. Biswajit Ruj, Sr. Scientist & HOD of EEG,

Arup Saha, Tech. Assistant, CSIR-CMERI



For queries, please write to :

Head, Business Development Unit,
CSIR-Central Mechanical Engineering Research Institute
(CSIR-CMERI), M.G. Avenue, Durgapur-713209, West Bengal, India



0343-6510237



director.cmeri@csir.res.in
bdg.cmeri@csir.res.in



<http://www.cmeri.res.in>

HAND PUMP ATTACHABLE IRON REMOVAL PLANT

TRL 9



**CSIR- National Environmental Engineering Research Institute
(CSIR-NEERI), Nagpur-440020, Maharashtra, India**

1. Name of CSIR Laboratory

CSIR-National Environmental Engineering Research Institute (CSIR-NEERI),
Nagpur - 440020, Maharashtra, India.

2. Name of Technology

Hand Pump Attachable Iron Removal Plant.

3. TRL Level: 9

- Nearly 900 plants are already installed by PHED and are working satisfactorily in iron-affected areas in Chhattisgarh State
- 240 units were installed in 4 districts of Assam in 1990 under the National Drinking Water Mission programme, in collaboration with PHED, Assam.

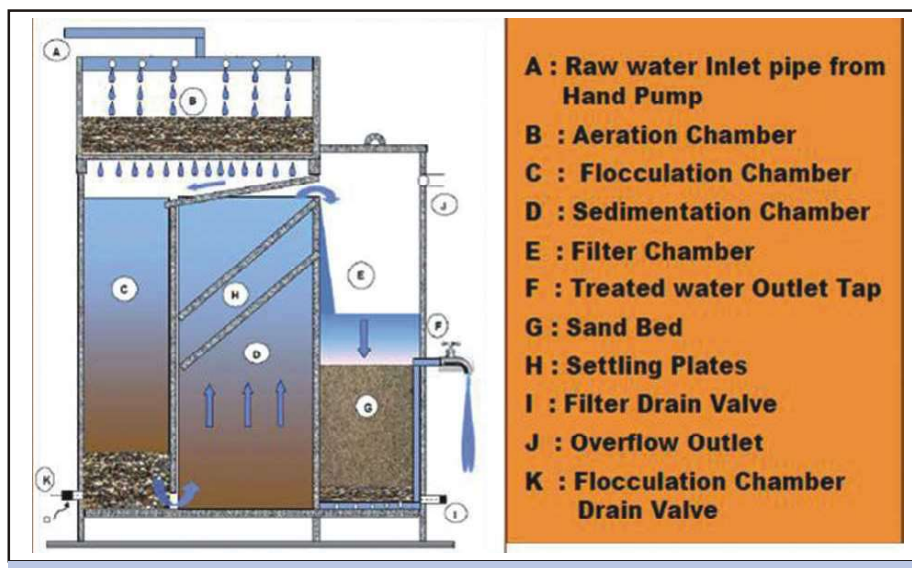

4. Preamble

Iron is one of the most important and valuable of all the elements. It is essential for the nutrition and healthy development of most plants and animals, and also man, and is very widely, distributed in nature. Iron is present in practically all soils, gravels, sands and rocks, sometimes in considerable amounts, but often only in traces. It is usually found in the form of oxides. Other common forms are ferrous carbonate and iron pyrites. Rain in percolating through soils and rocks, acquires iron in addition to other mineral constituents according to the character of geological formation, and there are very few waters, whether from surface or deep sources, which do not contain at least traces of iron. Iron in surface waters is mostly in insoluble or colloidal form. In deep sources, it is in a dissolved state, and exposure to the atmosphere results in oxidation, converting it to insoluble or colloidal forms.

Iron may originally be present in a water as derived from the source or be acquired from metals with which the water subsequently comes in contact. To decide this important point, it is necessary to examine samples collected on the spot from the source. If the latter is a deep bore-hole and samples can only be obtained from the pump delivery, a series of samples should be collected at intervals

through-out several hours' continuous pumping at maximum capacity. Should the examination of these samples show that the amount of iron present in the water decreases rapidly as pumping proceeds, it is fairly certain that some, if not all, of the iron is derived from the metal of the bore-hole tubing, strainer and rising main. This is required to be ascertained before further action.

The presence of iron in water is objectionable owing to the production of discolouration, turbidity, deposits, and a bad taste. Iron bearing waters have an astringent, metallic or bitter taste, and by combination of the iron with tannin impart an inky-colour to tea infusions. Water containing iron is undesirable for culinary use, as it causes brown-coloured deposits on vegetables during washing and cooking. It is also objectionable for laundry purposes and gives rise to 'iron-moulding' on linen and other white fabrics being washed. Even small traces of iron in water lead to the accumulation of appreciable deposits in distribution mains and reservoirs, which are often troublesome to water authorities and objectionable to consumers. Under such conditions, growths of iron bacteria often develop in the distribution system, when difficulties such as blocking of mains, meters, pipes, etc. are accentuated, and complaints of discoloured, turbid and unpalatable water becomes more serious. Iron bacteria are nuisance organisms that transform or deposit iron in the form of objectionable slime, resulting in fouling and plugging of wells and distribution systems. The bacteria also cause odour, taste, frothing, colour and turbidity in waters.

According to the Ministry of Drinking Water and Sanitation (MDWS), more than 50,000 habitations in 25 states in India are affected by excess iron in groundwater. Precipitation of soluble iron by oxidation with air, followed by sedimentation and filtration, is a relatively simple process used to remove iron from groundwater. Based on this process, NEERI has designed hand pump attachable iron removal plant with 1 m³/hr hydraulic loading. The plant is suitable for 250 persons with 40 lpcd and 10 hrs of operation. The plant has a diameter of 135 cm and a height of 150 cm.

5. Technical Description

a. The principle involves,

- Aeration
- Oxidation
- Precipitation
- Sedimentation
- Filtration

6. Design Details

6.1 Salient Features

- Oxidizes the dissolved iron: 1-30 mg/L
- High Removal Efficiency and easy to operate
- Single Unit System can provide 40 lpcd iron free water to 250 persons and can be installed on existing hand pumps.
- No need of chemical addition, skilled operator, electric power and mechanical parts
- Minimum maintenance with negligible operational cost
- Pre-fabricated FRP units can be installed quickly.

6.2 Equipment and Machinery Required for Deployment:

➤ Materials

- Fibre-glass Reinforced Plastic (FRP)/Reinforced Concrete (RCC) Structure as per requirement
- Sand bed
- Hand Pump
- Pipes (Plastic/Metal)
- Taps (Plastic/Steel).

6.3 Duration to the First Output after Installation:

The installed unit produced treated water free from Iron immediately after installation.

6.4 Is the Product Output Seasonal or Continuous:

The output of the Iron removal plant is continuous, as per the treated water requirement.

6.5 Quality and Stability of the Obtained Product:

Treated water is safe for drinking and cooking purposes, potable water, free of Iron (Within permissible limits). The technology is in compliance with various National and International guidelines/regulatory requirements. The treated water is free of turbidity and bacterial contamination.

6.6 Market Demand of the Product:

A safe, iron-free water supply has strong market demand in rural and urban India.

6.7 Resource Required (Raw Material, Energy, Water, etc.) for the operationalisation of the technology:

The basic material required for in RCC or FRP structure.

The sand media and essential plumbing.

6.8 Climatic and Geographical Conditions Required (Temperature, Rainfall, Humidity, Wind, Train, Soil Condition):

No, Climatic and Geographical Conditions are required for the installation and operation of the treatment unit.

6.9 Economic Unit Size:

The iron treatment units have been designed with different capacities to serve communities of various sizes, ranging from 250 to 1000 people. The treatment capacity ranges from 10 m³/h to 40 m³/h.

6.10 Indicative Investment:

The installation cost depends on the treatment unit's capacity.

6.11 Status of Commercialization of the Technology:

The Handpump attachable iron removal unit is a patented technology of CSIR-NEERI. The technology is ready for transfer.

7. Technology photos (Field installations)



NEERI's hand pump attachable Iron Removal Plant in Assam



HP attachable Iron Removal Plant FRP Structure
(Can be pre-fabricated and installed at the site in a few hours)



HP attachable Iron Removal Plant RCC Structure
(To be constructed onsite)

Awards :- Selected in DST - Lockheed Martin India Innovation Growth Programme 2013



For queries, please write to :

Director, CSIR-National Environmental Engineering Research Institute (CSIR-NEERI), Nehru Marg, Nagpur-440020, Maharashtra, India



+91-712-2249999



+91-712-2249900



director.neeri@csir.res.in
Dr. Atul Maldhure,
Dr. G.K. Khadse,
Dr. Paras Ranjan Pujari,
WRG, CSIR-NEERI



<http://www.neeri.res.in>
atul.maldhure@csir.res.in,
gajanan.khadse@csir.res.in,
paras.pujari@csir.res.in



HOUSEHOLD IRON REMOVAL UNIT

TRL 9



CSIR-National Environmental Engineering Research Institute
(CSIR-NEERI), Nagpur - 440020, Maharashtra, India

1. Name of CSIR Laboratory

CSIR- National Environmental Engineering Research Institute (CSIR-NEERI),
Nagpur - 440 020, Maharashtra, India.

2. Name of Technology

Household Iron Removal Unit.

3. TRL Level : 9

4. Preamble

The NEERI-ZAR can also be used as a domestic iron removal unit. The plant operates on the principle of oxidising iron with KMnO_4 and removing the precipitated iron by sand filtration. The required KMnO_4 dose is about 50% of the iron concentration in the water. The required dose of KMnO_4 is added to the ironcontaminated raw water and mixed with the stick. The chemical oxidises iron, forming a yellowish-brown precipitate. After 5-10 minutes of mixing, water is allowed to flow by gravity into the sand filter at a rate of 300-400 ml/min. Filtered water with iron concentration less than 0.2 mg/L is collected in the third plastic container and used for drinking and other domestic purposes.

Nearly 20 plants are being installed in the Tadoba Tiger Reserve Forest, Maharashtra, to supply water to forest guards staying in huts using handpumps. Most of the hand pumps water has an iron concentration in the range of 4-8 mg/L. The iron concentration in the treated water was 0.15-0.2 mg/L.

5. Design Details

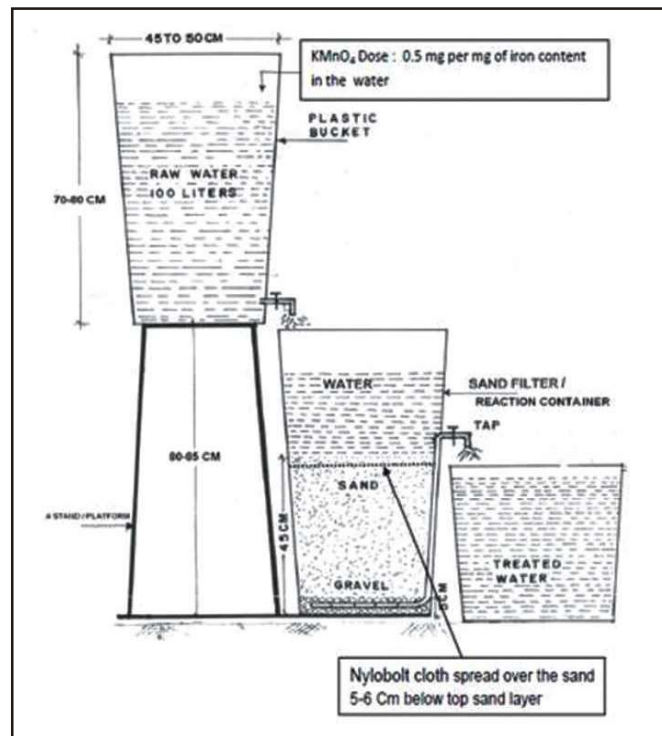

Schematic Diagram of Household Iron Removal Unit

6. Design Details

6.1 Salient Features

- Oxidation of iron by KMnO_4 and removal of precipitated iron by sand filtration
- The dose of KMnO_4 required is about 50% of the iron concentration in the water
- Suitable for remote places such as reserve forest, police /military camps
- 20 plants have been installed in Tadoba Tiger Reserve Forest, Maharashtra, to supply water to forest guards.

6.2 Equipment and Machinery Required for Deployment:

The household iron removal unit is designed for treating iron contamination at the household level. The basic requirements for the unit include two containers, each with a capacity of 20-30 litres, and a sand media filter with the necessary chemicals.

6.3 Duration to the First Output after Installation:

Immediately after installation.

6.4 Is the Product Output Seasonal or Continuous:

The unit's output is continuous, providing iron-free water for domestic use.

6.5 Quality and Stability of the Obtained Product:

The technology complies with various National and International guidelines/regulatory requirements.

6.6 Market Demand of the Product:

The product is highly desirable for producing iron-free water at the household level in remote areas.

6.7 Economic Unit Size:

The treatment unit has a capacity of 30-40 litres per family.

6.8 Indicative Investment:

The tentative cost of the treatment unit with a 40 L capacity is around Rs. 2500.

6.9 Status of Commercialization of the Technology:

The technology is ready for deployment, and the license is available free of cost for a societal mission.

7. Technology photos (Field installations)



Domestic Iron Removal Units installed in Tadoba Tiger Reserve Forest, Maharashtra for supply of water to Forest Guards



For queries, please write to :

Director, CSIR-National Environmental Engineering Research Institute (CSIR-NEERI), Nehru Marg, Nagpur-440020, Maharashtra, India



+91-712-2249999



+91-712-2249900



director.neeri@csir.res.in
Dr. Atul Maldhure,
Dr. G. K. Khadse,
Dr. Paras Ranjan Pujari,
WRG, CSIR-NEERI



<http://www.neeri.res.in>
atul.maldhure@csir.res.in,
gajanan.khadse@csir.res.in,
paras.pujari@csir.res.in

SECTION IV

TURBIDITY / MICROBIAL / PATHOGEN REMOVAL TECHNOLOGIES



FLAT SHEET ULTRA-FILTRATION (UF) MEMBRANE AND SPIRAL MODULE MAKING TECHNOLOGY FOR WATER PURIFICATION AND REMOVAL OF PATHOGENS

TRL 9



CSIR- Central Salt and Marine Chemical Research Institute
(CSIR-CSMCRI), Bhavnagar-364 002, Gujarat, India

1. **Name of CSIR Laboratory:**
CSIR-Central Salt and Marine Chemical Research Institute (CSIR-CSMCRI),
Bhavnagar - 364 002, Gujarat.
2. **Name of Technology:**
Flat sheet ultra-filtration (UF) membrane and spiral module making technology for
water purification and removal of pathogens.
3. **TRL Level: 9**

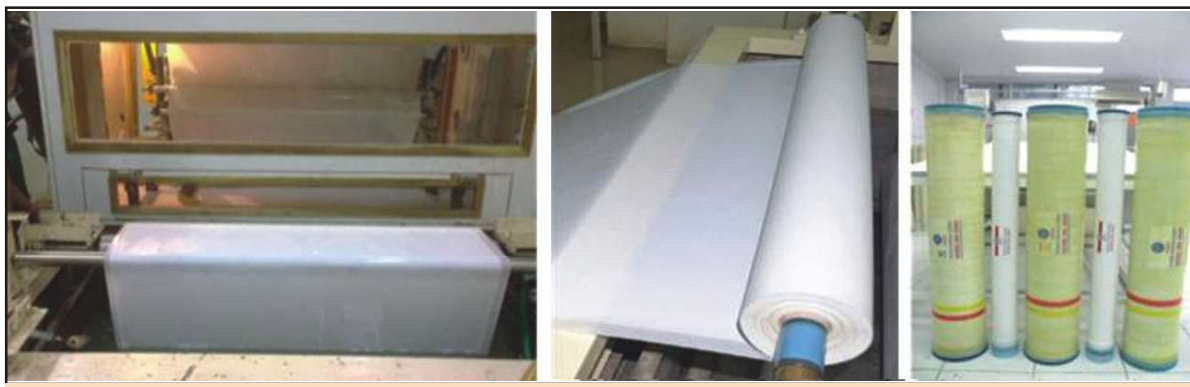

4. Preamble

For water disinfection to obtain potable water, for water reclamation from effluents, and as a pre-filter for reverse osmosis.

5. Technical Description

- A patented process for the manufacture of the membrane shall be provided.
- The process will be demonstrated at the CSIR-CSMCRI facility. The license fee, process demonstration fee, and annual recurring royalty (on ex-factory sale price) are payable and will be provided upon request.
- Attractive discounts for MSME's/start-up's.

6. Design Details

6.1 Salient Features

- The membranes are suitable for removing bacteria (6 log reduction), viruses (4 log reduction), turbidity, and colloidal materials (NTU reduction $\geq 99\%$) from contaminated water, thereby producing safe drinking water.
- The flux of the 40 module is 700-1000 LPH at 50 psi operating pressure.
- Eco-friendly.

6.2 Equipment and Machinery Required for Deployment:

- Membrane casting system and module fabrication system.

6.3 Market Demand of the Product:

- The technology is ready for technology transfer and can be implemented on commercial scale. The UF flat sheet membrane is also part of the RO membrane.

6.4 Resource Required (Raw Material, Energy, Water etc.) for Operationalization of the Technology:

- Polymer, solvent and other consumable items for module housing.

6.5 Economic Unit Size:

- Depends on the proposed capacity.

6.6 Status of Commercialization of the Technology:

- IN 169550; IN 186522.
- Commercialized
- Technology transferred to -
 - M/s Uniq Flux Membrane LLP, Pune,
 - M/s Rinzai Hydratech Pvt. Ltd, Ahmedabad
 - M/s OM Tech, Rajkot.



For queries, please write to :

Head,

Business Development & Information Management CSIR-Central Salt and Marine Chemical Research Institute (CSIR-CSMCRI), Bhavnagar – 364 002, Gujarat



0278-2567462,
Extn. No.: 7800



kamlesh.csmcri@csir.res.in
bdim.csmcri@csir.res.in



director.csmcri@csir.res.in



<http://www.csmcri.res.in>



HOLLOW FIBER ULTRA-FILTRATION MEMBRANES FOR WATER PURIFICATION AND REMOVAL OF PATHOGENS

TRL 9



CSIR- Central Salt and Marine Chemical Research Institute
(CSIR-CSMCRI), Bhavnagar-364 002, Gujarat, India

1. Name of CSIR Laboratory:

**CSIR-Central Salt and Marine Chemical Research Institute (CSIR-CSMCRI),
Bhavnagar - 364 002, Gujarat.**

2. Name of Technology:

Hollow fiber ultra-filtration membranes for water purification and removal of pathogens.

3. TRL Level: 9**4. Preamble**

Water purification.

5. Technical Description

- A patented process for the manufacture of the membrane shall be provided.
- The process will be demonstrated at the CSIR-CSMCRI facility.
- The license fee, process demonstration fee, and annual recurring royalty (on ex-factory sale price) are payable and will be provided upon request.
- Attractive discounts for MSME's/start-up's.

6. Design Details**6.1 Salient Features**

- The hollow fibers were found suitable for removing bacteria (6 log reduction), viruses (4 log reduction), turbidity, and colloidal materials (NTU reduction $\geq 99\%$) from contaminated water, thereby producing safe drinking water.
- Eco-friendly.

6.2 Equipment and Machinery Required for Deployment:

- Spinning system and module fabrication system.

6.3 Market Demand of the Product:

- The technology is ready for technology transfer and can be implemented on commercial scale. The HF UF membrane is used as a pretreatment filter for the RO membrane system.

6.4 Resource Required (Raw Material, Energy, Water etc.) for Operationalization of the Technology:

- Polymer, solvent and other consumable items for module housing.

6.5 Economic Unit Size:

- Total investment cost of plant/machinery: approx. ₹2.0 crore.
- Raw material cost per year: ₹1.5 crore (excluding land, manpower and recurring costs). Total cost of production per year: ₹1.5 crore (₹15,000/- as net cost of production and ₹30,000/- as selling price for each module).
- Sale price per unit per year: ₹3.0 crores per module unit (Taking 5 modules/day at the making facility and 200 days' operation of the unit).
- Net profit per year: ₹1.5 crore per annum
- Payback period: Around 2 years.

6.6 Status of Commercialization of the Technology:

- US 9364797, IN 2178DEL2010, EP 2616168 (A1), JP 5933557 (B2), WO 2012035402.
- Commercialized
- Technology transferred to - M/s Uniq Flux Membrane LLP, Pune.
- The performance of the fibers manufactured by M/s Uniqflux Membranes LLP was tested by Aqua Diagnostics, USA. Product is being exported by client.



For queries, please write to :

Head,
Business Development & Information Management CSIR-Central Salt and Marine
Chemical Research Institute (CSIR-CSMCRI), Bhavnagar – 364 002, Gujarat



0278-2567462,
Extn. No.: 7800



kamlesh.csmcri@csir.res.in
bdim.csmcri@csir.res.in



director.csmcri@csir.res.in



<http://www.csmcri.res.in>

HOLLOW FIBRE DOMESTIC WATER FILTER OF 1 LPM CAPACITY OPERATED UNDER GRAVITY WITHOUT ANY ELECTRICAL ENERGY

TRL 5



CSIR- Central Salt and Marine Chemical Research Institute
(CSIR-CSMCRI), Bhavnagar-364 002, Gujarat, India

1. Name of CSIR Laboratory:

CSIR-Central Salt and Marine Chemical Research Institute (CSIR-CSMCRI), Bhavnagar - 364 002, Gujarat.

2. Name of Technology:

Hollow fibre domestic water filter of 1 LPM capacity operated under gravity without any electrical energy.

3. TRL Level: 5

First customer trials in the field and feedback, or prototype/demonstration unit completed.

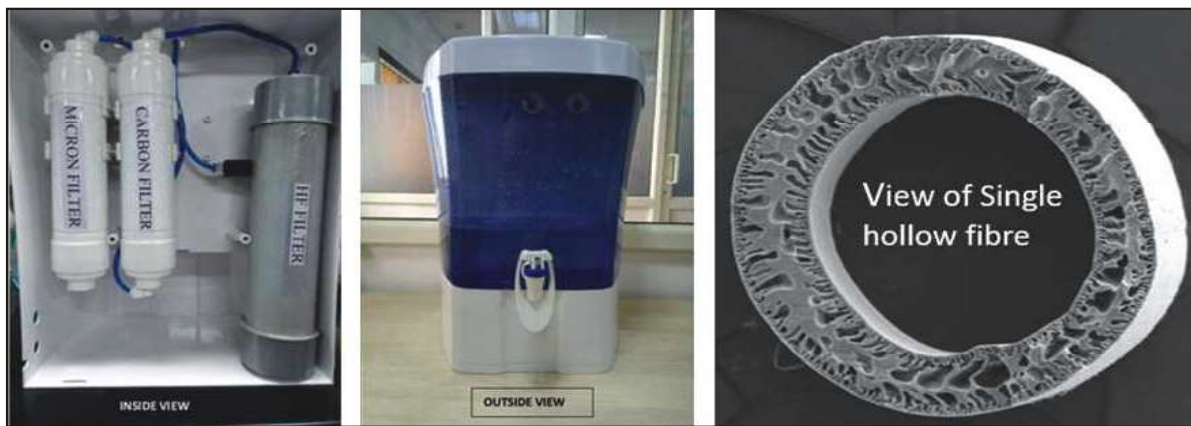
**4. Preamble**

Water Purification.

5. Technical Description

- A patented process for the manufacture of the membrane shall be provided. The process will be demonstrated at the CSIR-CSMCRI facility.
- The license fee, process demonstration fee, and annual recurring royalty (on ex-factory sale price) are payable and will be provided upon request.
- Attractive discounts for MSME's/start-up's.

6. Design Details**6.1 Salient Features**

- The unit is based on indigenously developed hollow fiber (HF) membranes with a MWCO of 90100 kDa.
- The HF module is preceded by one micron and carbon filter to remove the suspended particles, odour and colour (if any) from the feed water.
- The filter equipped with a water-level sensor operates under gravity (7-8 psi) without any electrical energy input.

- The HF exhibited >6 log reduction in Bacteria and requires a simple backwash with water every 1.5 months for disinfection of the supply tap water.
- Eco-friendly.

6.2 Equipment and Machinery Required for Deployment:

- Spinning system and module fabrication system.

6.3 Market Demand of the Product:

- The technology is ready for technology transfer and can be implemented on commercial scale.

6.4 Resource Required (Raw Material, Energy, Water etc.) for Operationalization of the Technology:

- Polymer, solvent and other consumable items for module housing.

6.5 Economic Unit Size:

- Depends on the scale of manufacturing; it Will be available on request.

6.6 Status of Commercialization of the Technology:

- US 9364797, IN 2178DEL2010, EP 2616168 (A1), JP 5933557 (B2), WO 2012035402.
- Technology transferred to - M/s. Memtrix, Ahmedabad



For queries, please write to :

Head,
Business Development & Information Management CSIR-Central Salt and Marine
Chemical Research Institute (CSIR-CSMCRI), Bhavnagar – 364 002, Gujarat



0278-2567462,
Extn. No.: 7800



kamlesh.csmcri@csir.res.in
bdim.csmcri@csir.res.in



director.csmcri@csir.res.in



<http://www.csmcri.res.in>



ATMOSPHERIC WATER GENERATOR WITH REMINERALIZATION

TRL 8



CSIR- Indian Institute of Chemical Technology
(CSIR-IICT), Hyderabad - 500 007, Telangana, India

1. Name of CSIR Laboratory

**CSIR- Indian Institute of Chemical Technology (CSIR-IICT),
Hyderabad - 500 007, Telangana, India.**

2. Name of Technology

Atmospheric water generator with Remineralization.

3. TRL Level: 8**4. Preamble**

Access to potable water has become increasingly challenging due to reliance on distant centralized purification plants, contamination of surface water sources, and rapid depletion of freshwater reserves. To address this, decentralized and automated systems for generating drinking water are essential, particularly in remote, arid, and water-scarce regions. Atmospheric Water Generators (AWGs) offer a viable solution by harvesting moisture directly from ambient air and converting it into safe drinking water, independent of conventional water sources. This proposal aims to develop and deploy an efficient, sensor-integrated AWG system for regions facing chronic water scarcity.

5. Technical Description

The proposed Atmospheric Water Generator (AWG) operates by drawing ambient air through micron-pleated filters and directing it over evaporator coils cooled below the dew point to induce condensation of atmospheric moisture. The cooled air stream is then mixed with ambient air to enhance condenser coil efficiency. The collected condensate is channelled into a storage tank, where it undergoes post-treatment using ultraviolet (UV) radiation and ozonation to eliminate microbial contaminants and improve water quality. The system is equipped with automated water-level control and integrated sensors that monitor relative humidity, temperature, water level, and total dissolved solids (TDS), enabling real-time assessment of operating conditions. Designed to operate effectively in regions with relative humidity above 90% and in semi-arid zones with humidity above 25%, the AWG is suitable for deployment in diverse climatic conditions.

6. Design Details**6.1 Salient Features**

- Captures atmospheric humidity to produce clean water.
- Operates efficiently in regions with humidity levels as low as 25%.
- System Capacity: 1000 Lit/day.
- Produces healthy re-mineralized water with TDS of around 100-150 ppm by dosing a proprietary salt mixture solution.
- Indigenization of technology by the introduction of renewable energy resources.
- The atmospheric water generator has shown strong potential for use in coastal regions such as Chennai and hilly areas.
- CSIR-IICT signed an MOU with Maithri Aquatech for Tech Transfer on the indigenization of a core component, re-mineralization, and post-treatment of water.

6.2 Equipment and Machinery Required for Deployment:

- Raw Water Pump, Pressure Gauges, Rotameters, Prefilters, Ultrafiltration Membrane Modules, UV light.

6.3 Duration to the First Output after Installation:

The system works instantly once installed.

6.4 Is the Product Output Seasonal or Continuous:

Continuous.

6.5 Quality and Stability of the Obtained Product:

Water from the AWG is safe, clean, and meets potable standards. Condensation yields water low in dissolved solids and free from common contaminants, while UV and ozone treatment ensure microbial safety. Integrated sensors monitor TDS, water level, and quality, maintaining stability over time. The closed-loop system minimizes contamination, providing consistently fresh, reliable drinking water in both humid and semi-arid regions.

6.6 Market Demand of the Product:

The demand for Atmospheric Water Generators (AWGs) is steadily increasing due to growing pressure on conventional freshwater resources and the rising frequency of water scarcity across rural, urban, and semi-arid regions. AWGs offer an immediate and sustainable alternative source of potable water.

6.7 Resource Required (Raw Material, Energy, Water etc.) for Operationalization of the Technology:

- Capture of moisture from humid air to get water. Dosing of the salt mixture is used to remineralize the water produced by the atmospheric water generator.

6.8 Climatic and Geographical Conditions Required (Temperature, Rainfall, Humidity, Wind, Train, Soil Condition):

Humidity.

6.9 Area Footprint of the Process:

Up to 10 m² area

6.10 Gestation Period of the Project:

The technology for water purification is fully commercialized.

6.11 Economic Unit Size:

- 150-500 L/day.

6.12 Indicative Investment:

The efficiency and potential of any technology depend on product quality, process performance, environmental benefits, and techno-economic feasibility. Cost estimation, summarised in the table below, includes fixed capital investment covering engineering, construction, land, equipment, installation, piping, and auxiliary facilities as well as operational and maintenance costs, such as energy, membrane replacement, and labour. The table presents the techno-economic analysis for producing re-mineralized water using 150-500 L/day solar-powered, membrane-integrated AWG units.

Atmospheric water generator (CAPACITY)	150 LPD	250 LPD	500 LPD
Base price of Solar Powered MEGHDOOT Premium (Rs.)	490,000	660,000	1,375,000
Total number of operating hours (h)	24	24	24
Water Generated at 100% efficiency in 24 hrs (L)	150	250	500
Power Consumption per hour (kWh)	2	3.5	5.5
No. of hours machine would run on solar (h)	6 to 8	6 to 8	6 to 8
No. of hours machine would run on power (h)	16 to 18	16 to 18	16 to 18
Approx. cost of grid power kW (Rs.)	5	5	5

Operational & Maintenance Expenses

Cost of grid power per day assuming the machine operates on grid power for 16 hrs a day (Rs)	160	280	440
Cost of power per liter (Rs.)	1.07	1.12	0.88
Annual maintenance cost per year@ 7.5% of the base price of the equipment [include (Ultrafiltration membrane replacement cost, Prefilter Cartridge Replacement (2 nos. Activated carbon, 1 no. Polypropylene Micron filter). Mineral cartridge filter]	15,000	26,000	50,500
AMC cost per liter (Rs.)	0.27	0.28	0.27
Total cost for generating 1liter of water	1.34	1.40	1.15
* Maintenance of Solar panels not included.			

6.13 Status of Commercialization of the Technology:

- Ready for commercialization. Technology on water purification and remineralization has been transferred to Incubate Maithri Aquatech Pvt. Ltd., Hyderabad.

7. Technology photos

(Field installations)



Atmospheric Water Generator of 150 L / day with Solar Panels at Govt. UPS DNT Adilabad



500 L / day AWG @ Ghoom School, Darjeeling



For queries, please write to :

Business Development and Research Management (BDRM) CSIR-Indian Institute of Chemical Technology (CSIR-IICT), Hyderabad – 500 007, Telangana, India



+91-40-27193992



Dr. S. Sridhar, Chief Scientist,



director.iict@csir.res.in



<http://www.iict.res.in>



ONEER™ : A NOVEL SOLUTION FOR SAFE DRINKING WATER

TRL 8



CSIR-Indian Institute of Toxicology Research
(CSIR-IITR), Lucknow - 226020, Uttar Pradesh, India

1. Name of CSIR Laboratory

CSIR- Indian Institute of Toxicology Research (CSIR-IITR), Lucknow - 226 020, Uttar Pradesh, India.

2. Name of Technology

Oneer™: A novel solution for safe drinking water.

3. TRL Level: 8**4. Preamble**

Oneer™ is useful for continuous water treatment. It is an innovative technology that eliminates all disease-causing pathogens, such as viruses, bacteria, fungi, protozoa, and cysts, to provide safe drinking water to communities in accordance with National and International standards prescribed for potable water (BIS, WHO, and EPA).

5. Technical Description

The device is based on the principle of anodic oxidation. Active oxygen species are produced in water under the influence of a modulated/pulsating constant Direct Current, using specially designed SS electrodes immersed in water, where electrical energy is converted to chemical energy. The oxidants produced by the electron reaction and ion migration mechanism have an extra-high potential and act on bacteria and other microorganisms more effectively than other oxidant-producing agents, such as chlorine, hypochlorite, UV and gamma radiation, Ozonation, etc., commonly used for drinking water disinfection.

**6. Design Details****6.1 Salient Features**

- An innovative modular design enables purification and disinfection of water.
- Pre-filters, depending on the water quality, remove particulate impurities, foul odours, colours, and other contaminants.
- High disinfection efficiency, with >8 Log reduction in bacteria.
- Inbuilt smart sensor systems provide real-time information on operational steps, self-cleaning mode, and automatic tank filling, ensuring 24/7 availability of safe drinking water.
- The unique disinfection process retains the natural essential minerals.
- The device's running cost is ~2 paisa/litre.
- High capacity option for communities with 450 LPH of treated water. The unique modular design allows scaling up the process from 5000 to 1 lakh L/day and beyond.
- Oneer™ is a maintenance and membrane-free "Safe Water & Save Water" technology.

6.2 Equipment and Machinery Required for Deployment:

- SS304 tanks of size 200 and 500 litres; SS316 electrodes; pipeline & valves; Electronic Control Unit; LCD & LED display, etc.

6.3 Duration to the First Output after Installation:

Up to an hour.

6.4 Is the Product Output Seasonal or Continuous:

Continuous.

6.5 Quality and Stability of the Obtained Product:

Up to the mark.

6.6 Market Demand of the Product:

Voluminous.

7.7 Resource Required (Raw Material, Energy, Water, etc.) for operationalization of the technology:

- Food grade stainless steel sheets (SS316L and SS303L), pre-filters, Microprocessor control unit, food-grade steel pipes, conductivity sensors, etc.

6.8 Climatic and Geographical Conditions Required (Temperature, Rainfall, Humidity, Wind, Train, Soil Condition):

No environmental constraints for running the system. There is no water wastage like other disinfection devices.

6.9 Area Footprint of the Process:

Domestic as well as Community.

6.10 Gestation Period of the Project:

NA.

6.11 Economic Unit Size:

- A smaller version provides 10 Litres of safe water per batch, suitable for household and small establishments, and can also be operated on a solar-powered battery. A larger version can continuously supply 450 Litres of water/ hour to communities.

6.12 Indicative Investment:

Depends upon the production.

6.13 Status of Commercialization of the Technology:

- The technology/ know-how is ready for commercialization.



For queries, please write to :

Director,

CSIR-Indian Institute of Toxicology Research, 31, Vishvigyan Bhawan, MG Marg,
Lucknow-226 001, Uttar Pradesh, India



+91-522-2217497



+91-522-2628227



director.iitr@csir.res.in



<http://www.iitr.res.in>

TERAFIL WATER PURIFICATION TECHNOLOGY FOR TREATMENT OF IRON & TURBIDITY FROM DRINKING WATER

TRL 9



CSIR-Institute of Minerals & Materials Technology
(CSIR-IMMT), Bhubaneswar 751 013, India

1. Name of CSIR Laboratory

**CSIR- Institute of Minerals & Materials Technology
(CSIR-IMMT), Bhubaneswar - 751 013, India.**

2. Name of Technology

Terafil water purification technology for treatment of iron & turbidity from drinking water.

3. TRL Level: 9

Fig 1. Basic parts of a 50 LPD capacity TERAFIL Filtration unit

4. Preamble

Safe drinking water is a basic need of human being. The availability of safe drinking water is a major concern worldwide; especially in developing countries. Major sources of drinking water include groundwater along with freshwater sources like lakes, rivers, streams etc. An estimated 1.8 billion people live in homes without safe drinking water across the world and over 3.5 million people die from water related diseases every year. In India the ground water sources are mostly contaminated with Iron, Fluoride, Arsenic, Salinity etc. Water filtration processes include treatment of water at both household as well as community level. Community water treatment systems include Reverse osmosis, Adsorption, Defluoridation, Ion exchange, Nanotechnology, Slow sand filtration, Chlorination etc. These large facilities are quite costly and maintaining hygiene level is challenging and expensive too. There are various types of house hold portable filters available in the market such as: UV based purifiers, UF based purifiers, RO based purifiers, gravity-based water purifiers etc.

However, the cost of these purifiers and its maintenance cost is very high and energy intensive; which is not affordable to rural population. These purifiers also require electricity for its operation, which is not available in many rural areas. Further, the requirement of electricity makes them non-suitable for their use during natural calamities. In addition, gravity-based water purifiers available in the market have expensive consumable components, which make these not suitable for long term drinking water solution for rural population.

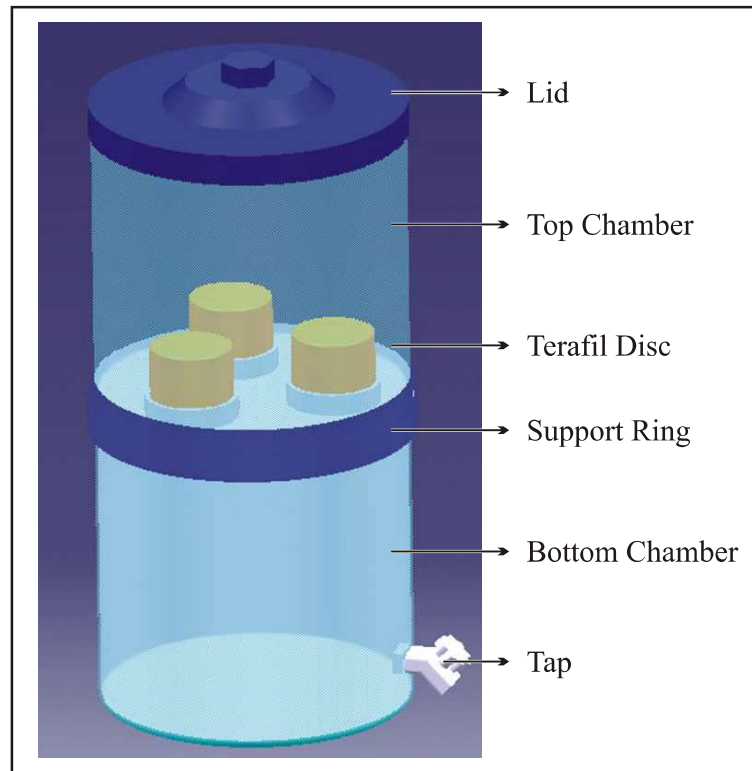
In India, many states like Bihar, Odisha, West Bengal, Jharkhand, Madhya Pradesh, Chhattisgarh, Assam, Karnataka etc. have reported iron levels more than the BIS permissible limit in drinking water. Excess iron in drinking water can lead to hemochromatosis which can cause damage to the liver, heart and pancreas. Also, it contributes to stains formation on utensils, clothes, walls & floors etc. which hamper their aesthetic look. There is always a need of sustainable technology which can remove excess iron along with turbidity from drinking water at an affordable cost.

Considering the requirement of rural and urban population, CSIR-IMMT has developed a low cost and sustainable water purification media (disc/candle) named TERAFIL; produced from locally available materials like red clay (pottery clay), sand and saw dust. It provides an efficient solution for water contaminated with turbidity and iron, for domestic and community applications. Quality of the product water is within BIS limits, particularly for turbidity & iron. Average life of TERAFIL filter media (disc/candle) are more than 03 years. Production and marketing of TERAFIL filter media in various capacities can also generate employment along with the drinking water solution. The TERAFIL filter media Technology has been wide propagated through technology transferred to 125 MSMEs/NGOs/ Govt. Agencies across the country.

5. Technical Description

TERAFIL filter media is made from a mixture of red clay (pottery clay), river sand and wood saw dust; without using any chemicals. TERAFIL media comprises of thin clay wall/membrane and each clay wall separated by large size pores. The thin clay wall contains ultra-fine capillary openings (sub-micron in size) which bridge the large pores. Water flows from one pore to another through capillary openings during filtration, leaving behind sediments and suspended particles on the top surface of TERAFIL filter media. Removal of iron (90-95%) & suspended particles (99%) from water is achieved along with significant removal of pathogens through TERAFIL filter media without clogging its core. Mild chlorination may be necessary for treatment of highly bacteriological contaminated surface raw water. The architecture of the filter media/disc ensures a high rate of filtration and long operational life. Cost of water purification is approximately Rs.0.02/- per lit.; considering total cost of the plant with operation & maintenance. Average rate of filtration is approximately 13ml/hr per unit area (cm²) with raw water having 50 NTU turbidity, 10 ppm iron and 250 mm water head. TERAFIL can be fitted at the bottom of any container for filtration and treatment of raw water.

6. Design Details

TERAFIL water purification systems are developed in different capacities ranging from 50 to

100,000 lit/day. The TERAFIL water purification units can be made from Polypropylene, LLDPE, FRP/GRP, Reinforced Cement Concrete (RCC) and Stainless-Steel material. The TERAFIL Filtration Plant can be designed to any capacity as per the actual requirement of drinking water in particular area considering the available water quality. The cost of the purification plant may vary depending upon the type of material used & the place of installation.



Fig 2. Terracotta based TERAFIL Filter



Fig 3. Ferro-cement ring based TERAFIL Filter



Fig 4. RCC based TERAFIL Filtration unit

6.1 Salient Features

- Turbidity removal - >99%
- Iron removal - 90-95%
- Life Cycle - >03 Years or 20,000 Liters per filter media (100 mm dia.)
- Low operation cost - 02 paisa / lit
- Filtration capacity - 50-100000LPD(canbescaleduptoanycapacity)
- Zero water wastage
- Electricity not required for filtration
- User friendly.



Fig 1. Terafil Filter Media

6.2 Equipment and Machinery Required for Deployment:

Filter Parts

TERAFIL filter media/disc, Top container, Bottom container, Top lid & Tap.

Step-1: Thoroughly wash the top & bottom container with warm water.

Step-2: Fix the "TERAFIL filter media" in the slots provided inside the top container as shown in the figure.

Step-3: Fix the tap in the slot provided on the bottom container.

Step-4: Lightly scrub the filter discs with the nylon scrubber to open up the pores.

Step-5: Place the top container on the bottom container as shown in the figure.

Step-6: Pour raw water into the top container until it gets filled completely and place the top lid on it.

Step-7: The filtered water will be stored in the bottom container. For the first time use, please discharge the filtered water at least twice before consuming.

Step-8: Keep the filter set in a clean and hygienic environment.

Note: The filter and the discs should be cleaned once or twice in a month.

6.3 Quality and Stability of the Obtained Product:

Quality Control (QC) and Quality Assurance (QA) are critical aspects in the production of TERAFIL water filter medias, ensuring that each filter media meets high standards of performance, safety and reliability. The final TERAFIL filter media products undergo performance testing to ensure the required filtration standards. This includes filtration with iron & turbid water to determine the flow rate and filtration efficiency in terms of Turbidity, Total iron and pH. The important parameters of the filter media like porosity, density, crushing strength etc. are determined before use.

Desirable Parameters for Approval of TERAFIL Water Filtration Disc:

- Crushing strength of kiln dry 50 mm thickness TERAFIL disc: $F_{cr50} = 7.0$ to 15.0 Kg/cm²
- Density of kiln dry TERAFIL candle (disc): $f_d = 0.70$ to 1.00 gm/cc
- Total porosity of kiln dry TERAFIL candle (disc): $P_{total} = 35\%$ to 55%
- Rate of discharge of turbid free water through unused TERAFIL candle (disc) after two hours operation at 250 mm water head over TERAFIL disc:

- Qava = 0.7 to 1.5 lit/hr for 100 diameter TERAFILE disc
- Qava = 4.0 to 7.5 lit/hr for 220 diameter TERAFILE disc
- Turbidity of product water (tested with turbid raw water) = < 1 NTU (Desirable; 0.1-3 NTU)
- Total iron in product water: < 0.3 mg/Ltr.
- Increase in pH of product water: Around 1.0

The Quality Control and Quality Assurance processes for TERAFILE water filters are designed to ensure that every filter meets the desired standards for performance, safety and reliability. By focusing on raw material quality, manufacturing processes and continuous improvement; TERAFILE filter media can provide effective and durable water purification solutions for desired application.

Safety Instructions

Since the TERAFILE filter media is made from naturally available non-toxic materials, it doesn't have any threat to humans during its operation or post operation. However, using a TERAFILE water filtration unit safely and effectively is essential for ensuring that you get clean and safe drinking water.

Do's

- Before using the filter for the first time, clean the ceramic filter media according to the manufacturer's instructions. This typically involves rinsing it with clean water to remove any dust or residues from the manufacturing process.
- Inspect the filter unit for any visible damage or defects before use. If you notice any issues, contact the manufacturer or supplier for assistance.
- If you notice a significant reduction in water flow or the filter is not producing water, it may be clogged. Clean the filter media thoroughly and ensure no blockages are present.
- For highly microbial contaminated water, add 3mg/liter of bleaching powder.
- When replacing or disposing the filter media, follow local regulations for disposal.

Don'ts

- During fixing the filter discs in the top chamber, avoid excess tightening, which may damage the filter disc.
- For cleaning of the filter discs, don't use any chemicals/detergents.

6.4 Status of Commercialization of the Technology:

The technology has been successfully commercialized through technology transfer to 125 MSMEs/NGOs/Govt. agencies.

7. Technology photos (Field installations)

After successful laboratory validation, the TERAFILE filter units were thoroughly monitored in user's environment. More than 2.0 lakh units of domestic filters (50 LPD) and 50,000 units of community filters (1000 LPD) are used in households, schools, villages etc. in many states of the country including North Eastern States and J&K under various national programmes of Department

of Drinking Water and Sanitation (DDWS), Govt. of India & CSR activities. It may be considered that this technology is providing around 60 million liters of safe drinking water daily across the country through Government initiatives. The TERAFIL Filter Units are being widely propagated through technology licensees across the country.



Fig 7. Installation of 5,000 Litre/day Capacity TERAFIL plant in Karnataka by PRED, Govt. of Karnataka



Fig 8. (a) 60KL/day TERAFIL Filter plant; (b) Source water inside TERAFIL Plant with filter media; (c) Raw water and product water quality.



Fig 9. Supply of domestic TERAFIL water filter in 350+ Govt. schools of five districts (Raipur, Mahasamund, Baloda Bazar, Janjgir Champa & Korba) of Chhattisgarh under CSR activity of SERPL-IOCL

As per the mandate of National Jal Jeevan Mission (NJJM); 'Functional Household Tap Connections' (FHTC) has to be provided to every rural household in the country. In view of this, CSIR-IMMT has designed and installed a 60,000 lit/day capacity TERAFIL water purification plant at Kanchilo village of Khordha District, Odisha; with the financial support from Department of

Drinking Water and Sanitation, Ministry of Jal Shakti, Govt. of India. The iron contamination of source water is more than 15 mg/l & turbidity is more than 100 NTU. The filter plant is efficient for removal of the excess iron & turbidity from the source water. The community water purification plant has been integrated with the rural water supply system of Panchayat Raj and Drinking Water Department, Government of Odisha; for supply of the filtered water to the households and public Institutions through Functional Household Tap Connection (FHTC) as per the mandate of National Jal Jeevan Mission (NJJM). The TERA FIL Water Purification Plant is purifying the contaminated source water and continuously supplying the treated water to the nearby villages for drinking purpose.

Expected Impacts

The TERA FIL Filtration Media Technology developed by CSIR-IMMT is providing affordable drinking water solution for both rural and urban population. The wide propagation of the technology is benefiting larger rural population living in remote areas, where advanced water purification technologies are not available. As per the mandate of National Jal Jeevan Mission (NJJM), large scale TERA FIL Water Purification Plant (60000 LPD) has been successfully demonstrated for providing drinking water through 'Functional Household Tap Connections' (FHTC) to rural households. As the filter media does not use any chemicals for its preparation, it provides a green & healthy water purification solution without affecting the environment. The TERA FIL Water Purification system has been proved as a reliable source for drinking water solution during natural calamities, as it is easy to use without requirement of electricity.

The TERA FIL filter media Technology has been wide propagated through technology transferred to 125 MSMEs/ NGOs/ Govt. Agencies across the country. Production and marketing of TERA FIL filter media in various capacities generates employment along with the drinking water solution.

Further; more numbers of large scale TERA FIL Water Purification Plants may be installed in different parts of the country through Jal Jeevan Mission Programme to provide safe drinking water to every household through tap connection.

As the TERA FIL Filter media is prepared from naturally available raw materials, has a simple preparation procedure, long life, low cost, and easy operation & maintenance, it can be widely accepted by the rural population as an appropriate drinking water solution.



For queries, please write to :

Strategy Planning & Business Development CSIR- Institute of Minerals & Materials Technology (CSIR-IMMT), Bhubaneswar – 751013 Odisha



+91-674-2567126,
+91-674-237-9401



91-674-2567160



dir@immt.res.in



<http://www.immt.res.in>

SAFE WATER AND SUSTAINABLE TECHNOLOGY INITIATIVE USING INDIAN KNOWLEDGE BASE (SWASTHIK)

TRL 6

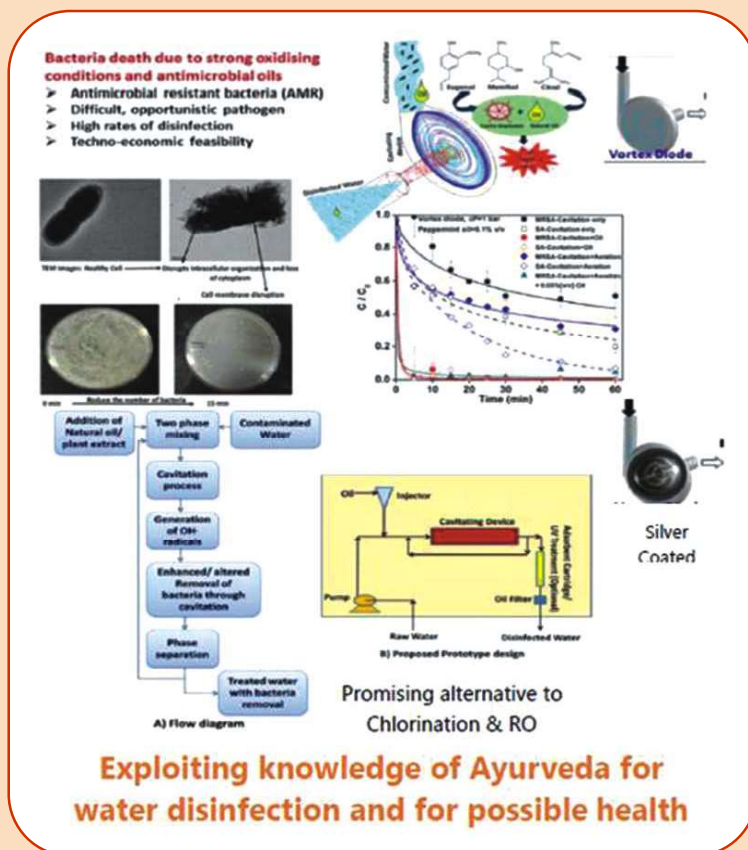

CSIR-National Chemical Laboratory
(CSIR-NCL), Pune 411 008, Maharashtra, India

1. Name of CSIR Laboratory

CSIR- National Chemical Laboratory (CSIR-NCL), Pune 411 008, Maharashtra, India

2. Name of Technology

Safe Water and Sustainable Technology Initiative Using Indian Knowledge base (SWASTIIK)

3. TRL Level : 6

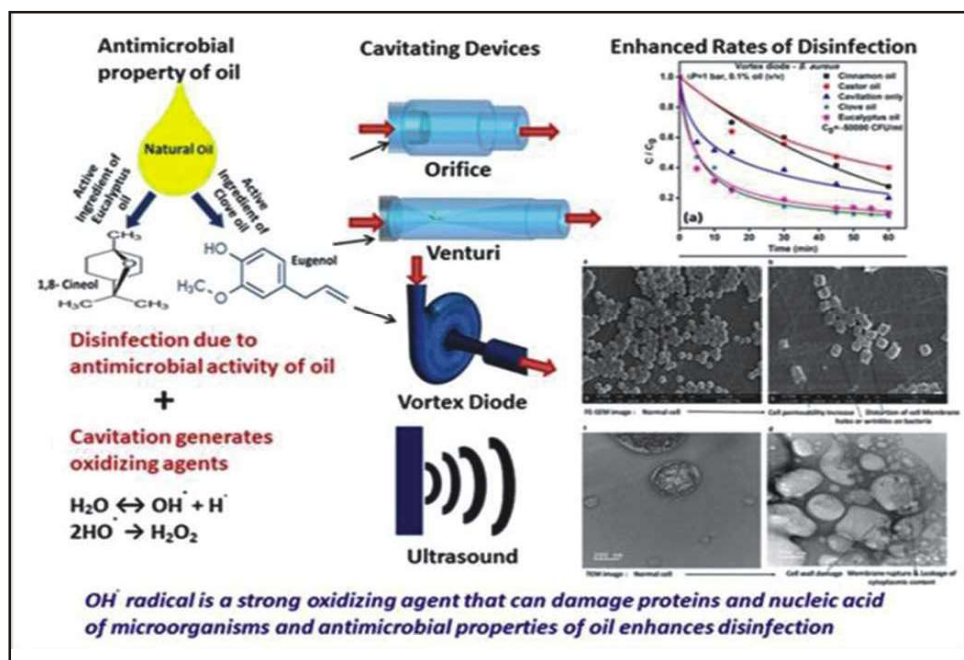

Fig 1. SWASTIIK with use of Natural Oils and Cavitation of any type

4. Preamble

Disinfection of water is essential for removing pathogenic microorganisms that are responsible for causing a number of water borne diseases- 88% of diseases in the developing world due to unsafe drinking water. The World Health Organization (WHO) estimates that more than 3.4 million people die every year from waterborne diseases and that disinfection is essential for providing safe drinking water by employing suitable methods (WHO, 2013, 2017). Broadly, the disinfection methods are chemical (Chlorination, ozonation, chemical treatment) and physical/ physico-chemical (UV light, cavitation, membrane). The common drawbacks include higher cost and long treatment times. Membrane filtration for water disinfection is not very effective, has many operational problems which ultimately increases the cost of treatment. The most common chemical method of water disinfection is chlorination. The problems associated with the chemical methods are many and vary according to the nature of the chemical used for disinfection. However, a serious disadvantage with most of the chemical methods is the formation of Disinfection By-products (DBP) that are extremely harmful and can be carcinogenic.

The problem statement in Safe Water Initiative can be simply stated as, "Develop methodology which provides safe and healthy drinking water at low (acceptable) cost with substantial ease of operation, scale-up and without harmful disinfection byproducts"

Cavitation using Vortex Diode:

The intensification of cavitation activity largely depends on efficient design of the cavitation reactors which will address the cost issue as well as the efficiency. We, at CSIR-NCL Pune, have developed newer cavitation technology using vortex diode which is highly efficient in Water & Wastewater Treatment- Disinfection and degradation of variety of organic pollutants/ emerging pollutants and refractory pollutants that are typically difficult to degrade. It generates no secondary waste, offers significant ease of operation and is believed to be cost effective as compared to other established advanced processes.

The cavitation process can be effectively combined with existing treatment methodologies such as coagulation, adsorption (for improving techno-economic feasibility contributing to "Water & Environment", "Swachh Bharat" and "Make in India" programs.

5. Technical Description

Vortex Diode for Water Treatment

We, at CSIR-NCL, have developed water and wastewater treatment technologies based on advanced oxidation process hydrodynamic cavitation where a specialized cavitation reactor was designed using vortex flow in cavitation, termed as vortex diode (US9422952B2, IN397769, EP2766314, PCT/IN2012/000676, US9725338B2, IN338553, PCT/IN2020/051007, WO 2021/111476 A1, US2021111476). The technology has been licensed to M/s VIVIRA Technologies, Pune and a large number of units of CSIR-NCL designs are presently being used in different industries. The vortex diode is a simple mechanical device of specific design without any moving elements. It consists of a tangential inlet, circular chamber for vortex generation and an axial outlet. Water/wastewater stream enters tangentially into the chamber and forms a strong vortex. The design is such that there is a sudden pressure drop to an extent that part of the liquid flashes into vapor forming cavities or bubbles (Fig. 1). The cavities are allowed to grow and finally to collapse in the designed manner. The collapse of the cavities, termed as implosion (opposite of explosion), generates extreme temperature (~10000 K) and pressure (~1000 atm) conditions at the point of implosion, causing water to split homolytically generating hydroxyl radicals. The hydroxyl radicals are highly oxidising species and oxidise the organic pollutants, envisaged results being complete mineralization, forming carbon dioxide and water.

Drinking Water Treatment

CSIR-NCL's water disinfection technology, SWASTIIK (Safe Water and Sustainable Technology Initiative from Indian Knowledgebase), a hybrid hydrodynamic cavitation technology, has the potential to provide alternative to existing disinfection processes including chlorination. The technology can completely eliminate the harmful bacteria such as gram- negative (*Escherichia coli*), gram-positive (*Staphylococcus aureus*) and also antimicrobial resistant (AMR) bacteria apart from relatively less researched, and difficult to remove opportunistic pathogen. SWASTIIK technology,

for the first time, successfully demonstrates the use of different natural oils such as eucalyptus oil, clove oil, peppermint oil, ajwain oil etc. in conjunction with hydrodynamic cavitation so as to effect cell destruction through the rupture of cell wall, oxidative damage and possible DNA denaturation. The technology reveals exceptionally high rates of disinfection and complete removal of all types of bacteria, within minutes, using very small concentration of oil, 0.1%. The oil after the treatment can be easily separated and recycled. The consequent reduction in the time of operation results in drastic lowering the cost of disinfection to an extent of ~Rs. 2.5/m³ or 0.25 Paise/L. The developed methodology, SWASTIIK, has the potential to provide viable alternative to chemical disinfection methods, provide ease of scale-up and also possible health benefits

SWASTIIK Technology has two entirely different variants:

- SWASTIIK Technology that makes use of natural oils having antibacterial properties for complete disinfection with ease of operation and cost comparable to existing Chlorination. This technology can be used with any type of cavitating device, or with mechanical mixing and does not essentially require Vortex Diode, per say, though vortex diode provides most efficient operation.
- SWASTIIK Technology- A non-chemical process for water disinfection using hydrodynamic cavitation. This methodology requires use of Newly invented Dual Activity Cavitation Reactors, such as Silver coated vortex Diode. Here, there is no addition of chemical in the process and is believed to be most efficient process with significant potential for commercial operations.

Dual Activity and Surface Coated Cavitation Reactors for Water Treatment:

The vortex diode as a cavitation reactor certainly offers significant advantages in terms of lower pressure drop, higher degradation efficiency, less maintenance and most importantly lower capital as well as operating cost compared to the conventional devices. Similar to the catalytic oxidation process, it would be instructive to add catalytic activity to the conventional cavitation without addition of the external catalyst

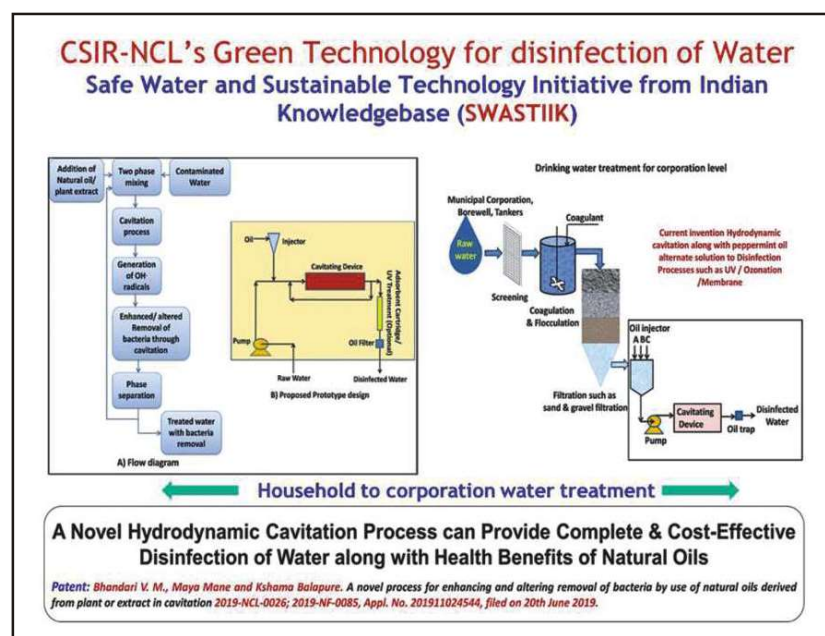

This concept led to dual-function cavitation reactors, where the reactor or its surface acts as a catalyst to degrade pollutants and eliminate biocontaminants. Copper and silver-coated vortex diodes proved highly effective, achieving up to 100% bacterial removal within minutes. These reactors outperform conventional systems, offering higher efficiency and lower costs in drinking water treatment.

6. Design Details

The invention introduces cavitation devices without moving parts that generate strong vortex flow to enhance pollutant degradation in water and wastewater treatment. Vortex diodes, with or without surface modification, produce oxidizing radicals for effective contaminant removal. Their design optimizes vortex stability and cavitation intensity for improved treatment efficiency.



Fig 6. CSIR-NCL's Vortex Diode- Conventional and novel Surface Coated Vortex Diode

Bhandari et al. Appl. No. 202211019277. (2022)

Bhandari et al. Appl. No. 202211070214, PCT/IN2023/051126, (2022)

6.1 Equipment and Machinery Required for Deployment:

The installation step involves procuring vortex diode of specified design and desired capacity (e.g. 40 m³/h capacity) from the authorized supplier(s) to who CSIR-NCL has licensed the technology. The vortex diode is a single piece of equipment without any moving elements and does not require any power for the device. The material of construction for the vortex diode should be decided using the guidelines (e.g. aluminum as MOC is generally suitable for non-corrosive effluents while SS 316 MOC need to be selected for corrosive effluent). The material of coating for internal surface needs to be decided as per the nature of pollutants for prominent catalytic effect and coating needs to be made skillfully using appropriate technologies such as electroplating. It also needs to be ensured that the coated material does not leach out.

Quality and Stability of the Obtained Product:

Vortex Diode is a mechanical device without any internal moving elements or requiring independent electrical power supply. It is a device that will need to withstand the required and recommended pressures and temperatures (Fluid pressure up to 4 kg/cm² and Temperatures typically max up to

70oC). Extreme care must be taken to ensure the quality of the manufactured product. Licensee, therefore, must ensure following steps for controlling the quality of product i.e. "Vortex Diode" to ensure that the product conforms to the specifications & requirements as documented in this dossier.

8. Technology photos (Field installations)

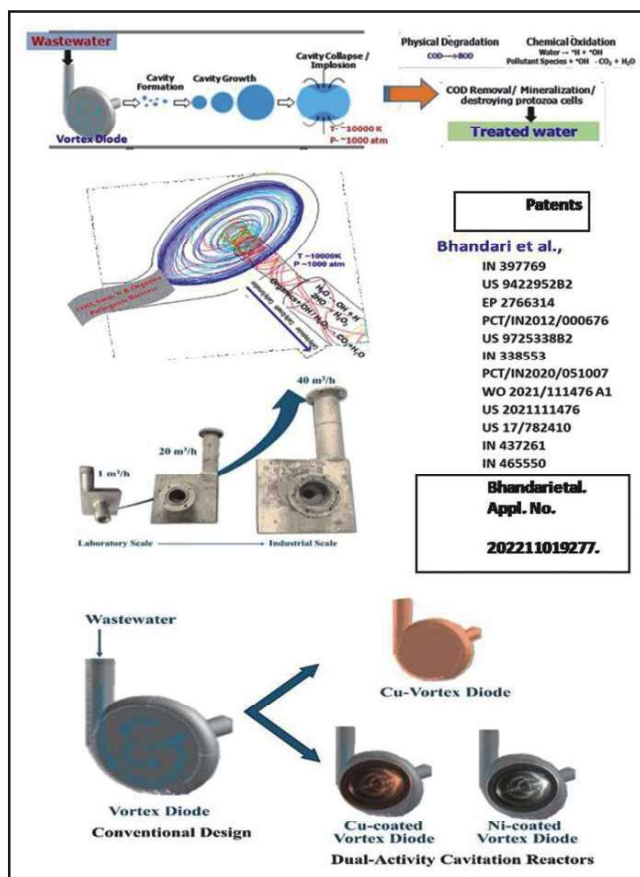

Fig 2. SWASTIHK- With use of Vortex Diode and Surface Coated Vortex Diode

Field Trials and Demonstration

The CSIR-NCL's Vortex Diode for Effluent Treatment technology has been successfully evaluated for different industry sectors and to the best of our knowledge, the technology is being used in ~50 industries. However, surface coated cavitation Vortex Diode has not been tested in field yet as the development pertaining to these new types of reactors is very recent (2022+) and currently these reactors have been tested using synthetic bio contaminated waters or model pollutants. The enhancements in the elimination of harmful bacteria is huge over and above other conventional cavitation reactors such as orifice, venturi etc. and even compared to our own patented previous version of Vortex Diode. The new dual activity surface coated vortex diode has the potential to replace the conventional cavitating devices implying huge benefits in cost of effluent treatment thereby drastically improving the techno-economic feasibility of the water treatment process. Some of these results are shown below.

- Indigenous technology will be available to city corporations for the Drinking water treatment plants.
- Common people for household application for insitu production of Safe drinking water.
- Rural applications for providing safe drinking water.
- Would improve cost effectiveness of the existing technologies and infrastructure through increased efficiency of the modified processes & also through assimilation of newer technologies developed by CSIR.
- Improved Efficiency & Economics through Newer Developments

Environmental Implications and Societal Benefits

Novel cavitation reactors and technologies are proposed for the first time for Drinking Water Treatment. A vortex diode as a cavitating device provides complete elimination of various harmful bacteria/ biocontaminants highlighting the potential of the Vortex Diode cavitation reactors in real-life applications, not just for increased efficiencies but also for significantly reduced costs in drinking water treatment, in general, and for the destructive removal of harmful biocontaminants; consequently providing sustainable processes for providing Safe Drinking Water in different types of applications. Figure 12 shows the expected impact of SWASTIK



For queries, please write to :

The Director,
CSIR- National Chemical Laboratory (CSIR-NCL),
Pune – 411008, Maharashtra, India



020-2590 2138, 25902125



020-25902160



director@ncl.res.in



<http://www.ncl.res.in>

“NEERI-ZAR” PORTABLE INSTANT WATER FILTER

TRL 9



CSIR-National Environmental Engineering Research Institute
(CSIR-NEERI), Nagpur - 440020, Maharashtra, India

1. Name of CSIR Laboratory

CSIR-National Environmental Engineering Research Institute (CSIR-NEERI), Nagpur - 440 020, Maharashtra, India.

2. Name of Technology

“NEERI-ZAR” Portable Instant Water Filter.

3. TRL Level: 9

Actual system proven in operational environment.



Community based Unit
(200 Lts capacity, Flow rate 100-120 Lts/hr.)



Household Unit
(30 Lts capacity, Flow rate 10-15 Lts/hr.)

4. Preamble

NEERI-ZAR' is a water purification system suitable for potable water supply, particularly under emergencies such as floods, where there is a high level of microbial contamination, and the flood waters are highly turbid. It is important to remove the microbial contamination and the turbidity (if any) from the flood waters before consumption. The NEERI-ZAR meets drinking and cooking water requirements on emergency basis and serves as a disaster management tool during floods. The NEERI-ZAR unit meets the requirements for drinking and cooking water in emergencies, serving as a disaster management tool to ensure a stable drinking water supply in flood-affected regions. The unit is designed for easy operation and does not require electricity. It is also easy to transport and install, making it extremely useful in flood-affected regions.

NEERI-ZAR comprises two types of treatment units: **compact household-based units** for single families and **community-based units** for groups of 6 to 10 households.

The community-based unit consists of two 100-litre plastic containers arranged at different elevations to enable gravity-driven flow. The upper container holds the raw water, to which the prescribed disinfectant is added. The water then flows by gravity into the lower container, which is fitted with a tap and a sand filter. In this container, the water passes downward through the filter bed,

collects at the bottom, and rises to the tap through connected piping. The filtered water is then collected in a third container. The water is safe and potable for use.

The household unit consists of two containers with a capacity of 20-30 liters each. The upper container contains the raw water and sand filter media (approximately 3 kg), which is placed in a Nylobolt bag. Disinfectant is added to the raw water, which is then appropriately stirred. The water then passes through the sand filter media and enters the bottom container, where it is stored for usage. The filtration process removes turbidity and suspended matter from the water. These precipitates get attached to the filter media and remain there. It is a gravity-based system and hence requires no power for operation. The deposition of these precipitates leads to clogging of the sand, which must be cleaned regularly.

NEERI-ZAR is a simple scalable process and apparatus using the locally available material for the treatment of raw water without use of even electric power make it quick response tool. It is a technically simple, cost-effective and reliable community drinking water purification system for supplying drinking water, which meets the guidelines of the World Health Organization (WHO) for turbidity and microbiological quality. It is well suited for those situations in which the operators and maintenance workers are not highly trained technicians, such as in rural or remote locations, and during emergencies.

The envisaged impact of the innovation (Economic/ Societal/ Strategic) are as follows:

- Reduction in expenditure on providing safe drinking water during emergency situation for which costly water treatment systems are utilized and sometimes military helicopter services are used when the villages are not approachable by surface transport
- Reduction in expenditure for medical treatment of water borne diseases due to drinking of water from the contaminated sources
- Reduction in epidemic, morbidity and mortality rate due to water borne diseases thereby improvement in quality of life

The intended end users are the population affected during the natural calamities (Cyclone, Floods). Also for the population residing in rural areas.

Table - Number of units installed during various emergencies

S.No.	Year	Place	Number of Units
1.	2006	Barmer District, Rajasthan	500 Nos.
2.	2009	Sunderbans, West Bengal	500 Nos.
3.	2011	Melghat, Maharashtra	10 Nos.
4.	2012	Tadoba, Maharashtra	16 Nos.
5.	2013	Dehradun, Uttarakhand	100 Nos.
6.	2015	Chennai, Tamil Nadu	500 Nos.
7.	2018	Thiruvananthapuram, Kerala	500 Nos.
8.	2018	Shrawasti District, Uttar Pradesh	200 Nos.
9.	2019	Patna, Bihar	500 Nos.
10.	2025	Jammu & Kashmir	250 Nos.

5. Technical Description

a. Patent Granted

Patent No.: 291012 (granted on 22/12/2017)

Patent Application No. : 196/DEL/2007

Date of Filing : 31 / 01 / 2007

6. Design Details

6.1 Salient Features

Unique features of the technology:

- NEERI-ZAR brings down the turbidity of filtered water to less than 3 NTU from raw water in the range 100-300 NTU.
- Removes organic matter and bacterial contamination as well.
- No change in dissolved salts in the water.
- Simple to fabricate and be assembled using locally available material.
- Easy to operate & minimum maintenance.
- Ease of transportation and installation.
- Reliable for emergency water supply.
- No power requirement. Gravity Operated.
- Produces potable water within an hour.
- Capacity 18-20L/h.
- Operating cost Rs. 3 per 100 litre.

6.2 Equipment and Machinery Required for Deployment:

Materials required for community - based unit		Materials required for Household unit	
Plastic container	2 Nos. (100 litres)	Stainless steel container	2 Nos. (20 litres)
Plastic tub	1 Nos. (20 - 30 litres)	Sand Filter Bag	3 liters
Plastic taps	2 Nos.	Nylon cloth Bag	1 No
Filter Sand	50 - 80 litres	Plastic Bottle	6 Nos. (Filled with 100 ml Disinfectant)
Gravel	10 litres (5-8mm) 4 litres (2-5mm)		
Nylobolt cloth	1600 - 2000 cm ²		
Disinfectant solution	500 ml (Conc.)		

6.3 Duration to the First Output after Installation:

Immediately after installing the unit.

6.4 Is the Product Output Seasonal or Continuous:

The output of the NEERI-ZAR units is continuous. The unit treats the required quantity of safe water to cater to drinking and cooking water requirements.

6.5 Quality and Stability of the Obtained Product:

The technology complies with various National and International guidelines/regulatory requirements. The treated water is free of turbidity and bacterial contamination.

6.6 Market Demand of the Product:

- Government Agencies are responsible for providing safe drinking water during emergencies like floods, heavy rainfall, or cyclones
- National and International Agencies like WHO and UNICEF are working to provide safe water to the community
- NGOs.

6.7 Resource Required (Raw Material, Energy, Water, etc.) for operationalization of the technology:

The raw material requirement is mentioned in the previous section for household and community-based units.

6.8 Climatic and Geographical Conditions Required (Temperature, Rainfall, Humidity, Wind, Train, Soil Condition):

The climatic conditions donot affect the output of the NEERI-ZAR unit.

6.9 Economic Unit Size:

The NEERI-ZAR units come in two sizes: Household and community-based units.

6.10 Status of Commercialization of the Technology:

NEERI-ZAR unit was developed for societal need, with the permission of the Director General, CSIR, New Delhi, this technology was made available free to everyone who wants to use it for a societal venture by providing the design details on the website. The IPR is not protected, keeping in view the need/use of this technology for societal mission. The user must provide the NEERI and CSIR names and logos for the unit.

7. Technology photos (Field installations)



Visit of Dr. Jitendra Singh, Hon'ble Union Minister of Science and Technology
& Vice President, CSIR, Kathua, Jammu (Sep 2025).



NEERI-ZAR installed at Baitu camp in Barmer District



Shrawasti District, Uttar Pradesh



International Project Innovation Award (PIA) instituted by International Water Association (IWA)



Nina Saxena Excellence in Technology Award 2008 instituted by IIT Kharagpur



Transportation and Installation of NEERI-ZAR in Sundarban District, West Bengal



For queries, please write to :

Director, CSIR-National Environmental Engineering Research Institute (CSIR-NEERI), Nehru Marg, Nagpur-440020, Maharashtra India.



+91-712-2249999



+91-712-2249900



director.neeri@csir.res.in
Dr. Atul Maldhure,
Dr. G.K. Khadse,
Dr. Paras Ranjan Pujari,
WRG, CSIR-NEERI



<http://www.neeri.res.in>
atul.maldhure@csir.res.in,
gajanan.khadse@csir.res.in,
paras.pujari@csir.res.in



SLOW SAND FILTRATION TECHNOLOGY

TRL 8



CSIR-National Environmental Engineering Research Institute
(CSIR-NEERI), Nagpur - 440020, Maharashtra, India

1. Name of CSIR Laboratory

**CSIR-National Environmental Engineering Research Institute (CSIR-NEERI),
Nagpur - 440 020, Maharashtra, India.**

2. Name of Technology

Slow Sand Filtration.

3. TRL Level: 8

Slow Sand Filtration Unit under construction
at village Chhati, Tehri Garhwal, HP

4. Preamble

Slow Sand Filtration is a water treatment process in which the water to be purified is passed through a porous bed of filter medium. During this passage, the water quality improves considerably through reductions, removals, and changes in the biological, physical, and chemical composition of the raw water.

Slow sand filtration is an efficient method for removing marginal turbidity, organic matter, particulate matter, and pathogenic organisms. It is, therefore, a particularly appropriate treatment method for surface water containing undesirable small quantities of such impurities. The turbidity of surface waters, however, limits the performance of slow sand filters, so that pre-treatment is often required.

Compared with other treatment methods for removing organic matter, pathogenic organisms, turbidity, and colour, slow sand filtration has many advantages. It is the only known unit operation that accomplishes such a high degree of concurrent improvement in the physical, chemical, and bacteriological quality of raw water.

5. Technical Description

- Most efficient and reliable method of surface water treatment for rural and municipal water supplies

- A single-step treatment for the removal of marginal turbidity, organic matter, particulate matter and pathogenic organisms from water
- Suitable pre-treatment is required when higher turbidity (>30 NTU) persists for a prolonged period.
- Relatively simple design and construction
- Can be constructed with locally available material by local craftsmen
- Operation and maintenance can be taken care of by members of the local community
- The only known unit operation that accomplishes a high degree of concurrent improvement in the physical, chemical, and bacteriological quality of raw water.

6. Design Details

6.1 Salient Features

- Ideal for small-scale rural water supply
- Low cost technology
- No chemicals are required (except disinfectant)
- No power-driven mechanical parts are present
- No wash water is needed for the cleaning of the filter
- Sludge is in small quantities and has a very high dry matter content.

6.2 Is the Product Output Seasonal or Continuous:

The treatment unit's output continues.

6.3 Quality and Stability of the Obtained Product:

The treated water is safe with no change in taste.

6.4 Resource Required (Raw Material, Energy, Water etc.) for Operationalization of the Technology:

It requires a brick structure with the needed pipings.

7. Technology photos (Field installations)

NEERI has designed, constructed, and commissioned two slow sand filters at the village of Chhati in the hilly region of Tehri Garhwal, in collaboration with the participating organisation, Himalayan Consortium for Himalayan Conservation (HIMCON), New Delhi, in June 2005. The SSFs were installed as a part of the project “Study the hilly region water resources management for safe drinking water” sponsored by the Department of Drinking Water Supply, Rajiv Gandhi National Drinking Water Mission, Ministry of Rural Development, Govt. of India, New Delhi. This is the first SSF in a hilly region for a small community water supply.



Slow Sand Filters designed, constructed and commissioned by NEERI at village Chhati in hilly region of Tehri Garhwal

**For queries, please write to :**

Director, CSIR-National Environmental Engineering Research Institute
(CSIR-NEERI), Nehru Marg, Nagpur-440020, Maharashtra India.



+91-712-2249999



+91-712-2249900



director.neeri@csir.res.in

Dr. Atul Maldhure,
Dr. G.K. Khadse,
Dr. Paras Ranjan Pujari,
WRG, CSIR-NEERI



<http://www.neeri.res.in>
atul.maldhure@csir.res.in,
gajanan.khadse@csir.res.in,
paras.pujari@csir.res.in

SECTION V

REVERSE OSMOSIS AND DESALINATION TECHNOLOGIES





TRL

9

**FLAT SHEET THIN FILM COMPOSITE (TFC)
REVERSE OSMOSIS MEMBRANE AND SPIRAL MODULE
MAKING TECHNOLOGY FOR
BRACKISH & SEAWATER DESALINATION
INCLUDING BIO-DEGRADATION OF
ORGANIC EFFLUENT STREAM GENERATED
IN THE MEMBRANE PROCESS DEVELOPMENT**

TRL 9

**CSIR- Central Salt and Marine Chemical Research Institute
(CSIR-CSMCRI), Bhavnagar-364 002, Gujarat, India**

1. Name of CSIR Laboratory:

CSIR-Central Salt and Marine Chemical Research Institute (CSIR-CSMCRI), Bhavnagar - 364 002, Gujarat.

2. Name of Technology:

Flat sheet thin film composite (TFC) reverse osmosis membrane and spiral module making technology for brackish & seawater desalination, including bio-degradation of organic effluent stream generated in the membrane process development.

3. TRL Level:

- For brackish water desalination membrane: /TRL9
- For seawater desalination membrane: /TRL5
- For effluent biodegradation: /TRL4



Demonstration facility in CSIR-CSMCRI (1, 2) and product (3)

4. Preamble

Sea and brackish water desalination; treatment of wastewater containing aprotic polar solvents: DMF, DMAc and NMP.

5. Technical Description

- Fabrication of ultrafiltration membrane.
- Fabrication of thin film composite RO membranes for brackish water and or seawater desalination.
- Effluent treatment (optional).
- Module making.

6. Design Details**6.1 Salient Features**

- High flux and high salt rejecting antifouling membrane.
- Simple biodegradation of DMF (up to 30000 ppm within 48 h), DMAc and NMP (up to 10000 ppm within 96-120 h) contaminated water.
- Eco-friendly.

6.2 Equipment and Machinery Required for Deployment:

- Membrane casting/coating machine;
- module rolling machines;
- membrane/module testing plant.

6.3 Market Demand of the Product:

- The BWRO membrane technology is commercialized.
- The seawater membrane technology is ready for demonstration at 100 m² batch.
- The effluent treatment technology is ready for demonstration at bench scale.

6.4 Resource Required (Raw Material, Energy, Water, etc.) for Operationalization of the Technology:

- Fabric, Polymer, Solvents, Water, Chemicals.

6.5 Climatic and Geographical Conditions Required (Temperature, Rainfall, Humidity, Wind, Train, Soil Condition):

6.6 Economic Unit Size:

- Depends on the proposed capacity.

6.7 Status of Commercialization of the Technology:

- IN 244150; US 10384171B2; EP 2922617B1; WO 2014080426A1; EP 2833990A1.
- Commercialized
- BWRO membrane technology know-how transferred to-
 - Uniqflux membranes LLP, Pune
 - OMTECH, Rajkot
 - Rinzai Hydratech Pvt. Ltd.



For queries, please write to :

Head,

Business Development & Information Management CSIR-Central Salt and Marine Chemical Research Institute (CSIR-CSMCRI), Bhavnagar – 364 002, Gujarat



0278-2567462,
Extn. No.: 7800



kamlesh.csmcri@csir.res.in
bdim.csmcri@csir.res.in



director.csmcri@csir.res.in



<http://www.csmcri.res.in>



NANO FILTRATION MEMBRANE FOR WATER SOFTENING BY PARTIAL DESALINATION, DECONTAMINATION AND DISINFECTION

TRL 5

**CSIR- Central Salt and Marine Chemical Research Institute
(CSIR-CSMCRI), Bhavnagar-364 002, Gujarat, India**

1. **Name of CSIR Laboratory:**
CSIR-Central Salt and Marine Chemical Research Institute (CSIR-CSMCRI),
Bhavnagar - 364 002, Gujarat.
2. **Name of Technology:**
Nano filtration membrane for water softening by partial desalination, decontamination and disinfection.
3. **TRL Level: 5**
Prototype/ demonstration unit completed. Membrane preparation in the scale of 50 sq. m.; Spiral wound membrane modules of 4"×14" and 4"X 40".

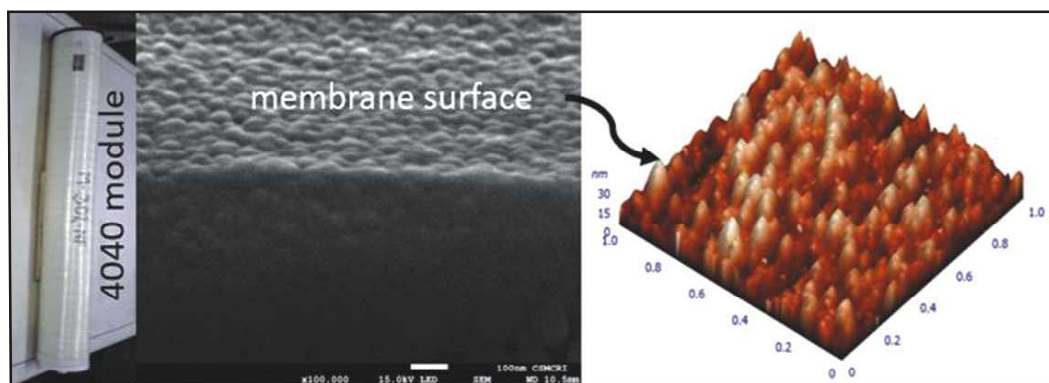

4. Preamble

Water purification by partial desalination, decontamination and disinfection.

5. Technical Description

- A patented process for the manufacture of the membrane shall be provided. The process will be demonstrated at the CSIR-CSMCRI facility.
- The license fee, process demonstration fee, and annual recurring royalty (on ex-factory sale price) are payable and will be provided upon request.
- Attractive discounts for MSME's/start-up's.

6. Design Details

6.1 Salient Features

- Low pressure nanofiltration membrane process based on an indigenously developed high-flux nanofiltration membrane.
- It is ultrathin-film composite membrane based on the cross-linked polyamide selective layer supported on uniformly and highly porous support, which exhibited the pure water permeability of 95-150 LMH at 150 psi, Na_2SO_4 rejection 99- 99.5 %, MgSO_4 95-99 %, NaCl rejection 25 ± 5 %.
- Eco-friendly.

6.2 Equipment and Machinery Required for Deployment:

- Spinning system and module fabrication system.

6.3 Market Demand of the Product:

- The technology is ready for technology transfer and can be implemented on commercial scale.

6.4 Resource Required (Raw Material, Energy, Water etc.) for Operationalization of the Technology:

- Polymer, solvent and other consumable items for module housing.

6.5 Economic Unit Size:

- Depends on the scale of manufacturing.
- Will be available on request.

6.6 Status of Commercialization of the Technology:

- IN427716, IN 201811031932.
- Technology is ready for transfer.

**For queries, please write to :****Head,**

Business Development & Information Management CSIR-Central Salt and Marine Chemical Research Institute (CSIR-CSMCRI), Bhavnagar – 364 002, Gujarat



0278-2567462,
Extn. No.: 7800



kamlesh.csmcri@csir.res.in
bdim.csmcri@csir.res.in



director.csmcri@csir.res.in



<http://www.csmcri.res.in>



TRL
5

REJUVENATION OF THE END-OF-LIFE SEAWATER REVERSE OSMOSIS MEMBRANE ELEMENTS

TRL 5

CSIR- Central Salt and Marine Chemical Research Institute
(CSIR-CSMCRI), Bhavnagar-364 002, Gujarat, India

1. **Name of CSIR Laboratory:**
CSIR-Central Salt and Marine Chemical Research Institute (CSIR-CSMCRI),
Bhavnagar - 364 002, Gujarat.
2. **Name of Technology:**
Rejuvenation of the end-of-life seawater reverse osmosis membrane elements.
3. **TRL Level: 5**
(Pilot plant scale development and demonstration)



The pilot plant membrane rejuvenation facility at CSIR-CSMCRI ESF

4. Preamble

Applications in desalination and water reuse plants for the same or alternative applications, e.g., wastewater reuse, brackish water reverse osmosis, grey water treatment, etc.

5. Technical Description

- Depends on the scale;
- Will be available on request.

6. Design Details

6.1 Salient Features

We have converted the discarded membranes into useful membranes for the following applications:

- Low salinity brackish water desalination/wastewater treatment and reuse.
- Partial substitution of the original application by enhancing the flow rate but maintaining the salt rejection performance.
- Conversion to ultrafiltration-like membrane elements by removal of polyamide barrier layer.
- The second life of the membrane will be a “waste to wealth” proposition.

- From an environmental perspective, it is essential to extend the life cycle of membrane elements, as membrane waste is hazardous polymeric waste. Thus, it renders an environmentally friendly proposition. The treatment chemicals are neutralized before disposal.

6.2 Equipment and Machinery Required for Deployment:

- Pumps, membrane test rig, reactor, piping system, tanks, etc.

6.3 Market Demand of the Product:

- The technology is ready for technology transfer and can be implemented on commercial scale.
- Industry-specific customization may be required.

6.4 Resource Required (Raw Material, Energy, Water etc.) for Operationalization of the Technology:

- Chemicals, alcohol, acid, surfactants.

6.5 Economic Unit Size:

- The rejuvenated membrane cost will be about 15-20% of the new membrane cost.
- It depends on the degree of membrane fouling and the desired use of the membrane in its second life.

7.6 Status of Commercialization of the Technology:

- IN202211030752.
- Not yet licensed; discussions with industry are underway, with customer field trials.



For queries, please write to :

Head,

Business Development & Information Management CSIR-Central Salt and Marine Chemical Research Institute (CSIR-CSMCRI), Bhavnagar – 364 002, Gujarat



0278-2567462,
Extn. No.: 7800



kamlesh.csmcri@csir.res.in
bdim.csmcri@csir.res.in



director.csmcri@csir.res.in



<http://www.csmcri.res.in>



**A HIGH RECOVERY ED-RO HYBRID PROCESS
FOR WATER PURIFICATION / DESALINATION
WITH HIGH WATER RECOVERY**

TRL 5

**CSIR- Central Salt and Marine Chemical Research Institute
(CSIR-CSMCRI), Bhavnagar-364 002, Gujarat, India**

- 1. Name of CSIR Laboratory:**
CSIR-Central Salt and Marine Chemical Research Institute (CSIR-CSMCRI),
Bhavnagar - 364 002, Gujarat.
- 2. Name of Technology:**
A high recovery ED-RO hybrid process for water purification/desalination with high water recovery.
- 3. TRL Level: 5**



4. Preamble

Hybrid electro-dialysis-reverse osmosis domestic desalination unit for high recovery of product water.

5. Technical Description

- Process configuration of ED and RO systems for desalination with a higher cumulative water recovery efficiency (>60%).
- Design of ED-RO hybrid domestic desalination unit.

6. Design Details

6.1 Salient Features

- Reverse osmosis (RO) membrane-based domestic water desalination/purification units have gained wide acceptance even in India. Unfortunately, the recovery of product water from these units varies between 30 and 60%, depending on the total dissolved solids (TDS) of the feed water. Such low recovery of product water during desalination is a serious problem, given water scarcity. Further, tap water salinity is increasing due to groundwater depletion.

- Alternatively, the electrodialysis (ED)-RO hybrid process offers high recovery of product water from brackish water without compromising on water quality.
- In a hybrid process, the ED unit operates in the high TDS region (low system resistance and thus high efficiency), and the RO system operates in the low TDS region to reduce salinity load on the membrane.

6.2 Equipment and Machinery Required for Deployment:

- RO and electro dialysis units.

6.3 Market Demand of the Product:

- The technology is scalable, with desalinated water productivity ranging from 10 LPH to 500 LPH, and is suitable for both domestic and societal uses.
- The cost of such units will vary with productivity and feedwater quality.

6.4 Resource Required (Raw Material, Energy, Water etc.) for Operationalization of the Technology:

- Surface/ground water.

6.5 Economic Unit Size:

- Depends on the scale of manufacturing; it Will be available on request.

6.6 Status of Commercialization of the Technology:

- IN 201001418-11.
- Yet to be licensed.



For queries, please write to :

Head,

Business Development & Information Management CSIR-Central Salt and Marine Chemical Research Institute (CSIR-CSMCRI), Bhavnagar – 364 002, Gujarat



0278-2567462,
Extn. No.: 7800



kamlesh.csmcri@csir.res.in
bdim.csmcri@csir.res.in



director.csmcri@csir.res.in



<http://www.csmcri.res.in>

**ELECTRO-DIALYTIC DESALINATION
FOR PRODUCTION OF
MINERAL-BALANCED POTABLE WATER**

TRL 6



**CSIR- Central Salt and Marine Chemical Research Institute
(CSIR-CSMCRI), Bhavnagar-364 002, Gujarat, India**

1. **Name of CSIR Laboratory:**
CSIR-Central Salt and Marine Chemical Research Institute (CSIR-CSMCRI), Bhavnagar - 364 002, Gujarat.
2. **Name of Technology:**
Electro-dialytic desalination for the production of mineral-balanced potable water.
3. **TRL Level: 6**

4. Preamble

Water desalination unit with improved protocols to produce mineral-balanced alkaline water.

5. Technical Description

- Design for a domestic ED unit for mineral-balanced potable water.
- Ion-exchange membranes preparations.

6. Design Details

6.1. Salient Features

- 350-525 ppm; Na⁺: 30-60 ppm; Mg²⁺: 20-30 ppm; Ca²⁺: 50-70 ppm; K⁺: 5-15 ppm; Cl⁻: 50-75 ppm; SO₄²⁻: 100-150 ppm; and CO₃²⁻/HCO₃⁻: 100-125 ppm.
- Water desalination is a common practice to achieve the overarching goal of augmenting the drinking water supply. Reverse osmosis (RO) has been practised commercially. During desalination, the salinity is lowered which is desired but the concentrations of nutritious constituents are also reduced excessively which is undesirable.
- Specifications for ideal drinking water should be: total dissolved solid: 350-525 ppm; Na⁺: 30-60 ppm; Mg²⁺: 20-30 ppm; Ca²⁺: 50-70 ppm; K⁺: 5-15 ppm; Cl⁻: 50-75 ppm; SO₄²⁻: 100-150 ppm; and CO₃²⁻/HCO₃⁻: 100-125 ppm. In the case of RO desalinated water, the product water contains low concentrations of nutritive minerals (Mg²⁺, Ca²⁺, K⁺, SO₄²⁻, and CO₃²⁻/HCO₃⁻), while the relative proportions of Na⁺ and Cl⁻ are very high. Remineralisation is one approach to correct the imbalance, but it is not always practised.
- In the RO unit, the TDS of the product water has been controlled by a small amount of bypass of the reject stream, in which NaCl is the major constituent. Thus, the development of a methodology that enables desalination with better retention of nutritious ions would be of considerable interest.
- We developed an ED process for the separation of mono- and bivalent ions employing polyaniline (PANI)-modified interpolymer-type ion-exchange composite membranes.
- Due to sieving and hydrophobic effects, the PANI coating was found to improve the retention of nutritious minerals in desalinated water.
- Eco-friendly.

6.2. Equipment and Machinery Required for Deployment:

- Ion exchange membrane making facilities.

6.3. Market Demand of the Product:

- The technology is scalable, with desalinated water productivity ranging from 10 LPH to 500 LPH, and is suitable for both domestic and societal uses.
- The cost of such electrodialysis units may vary from Rs. 30,000/ to Rs. 15,00,000/, depending on productivity.

6.4. Resource Required (Raw Material, Energy, Water etc.) for Operationalization of the Technology:

- Surface/ground water.

6.5. Economic Unit Size:

- Depends on the scale of manufacturing; it will be available on request.

6.6. Status of Commercialization of the Technology:

- WO 2014188450 A1; IN 2012DE3599 A.
- Yet to be licensed.

**For queries, please write to :**

Head,

Business Development & Information Management CSIR-Central Salt and
Marine Chemical Research Institute (CSIR-CSMCRI), Bhavnagar – 364 002, Gujarat



0278-2567462,
Extn. No.: 7800



kamlesh.csmcri@csir.res.in
bdim.csmcri@csir.res.in



director.csmcri@csir.res.in



<http://www.csmcri.res.in>



ELECTRO-DEIONIZATION UNIT FOR PRODUCING ULTRAPURE WATER

TRL 8



CSIR- Central Salt and Marine Chemical Research Institute
(CSIR-CSMCRI), Bhavnagar-364 002, Gujarat, India

- 1. Name of CSIR Laboratory:**
CSIR-Central Salt and Marine Chemical Research Institute (CSIR-CSMCRI), Bhavnagar - 364 002, Gujarat.
- 2. Name of Technology:**
Electro-deionization unit for producing ultrapure water.
- 3. TRL Level: 8**

4. Preamble

Ultrapure water (resistivity: 18.2 MΩ cm; pH: 7.0) and 10-50 litres per hour using indigenously developed ion-exchange membranes for electronics, pharmaceuticals and other niche applications.

5. Technical Description

- Design for electro-deionization unit for producing ultrapure water (resistivity: 18.2 MΩ cm.)
- Process for an ion-exchange membrane.
- Demonstration of the process.

6. Design Details

6.1. Salient Features

- All components, such as ion-exchange membranes, resins, and electrodes are indigenously available.
- Continuous regeneration of mixed-bed resin.
- Steady quality control for the product water (resistivity: 18.2 MΩ at 25 °C; TOC: 1 ppb; pH: 7.00; flow rate: 15 LPH).
- Groundwater or municipal water may be used as feed water.
- High percentage of water recovery.
- Maintenance cost: Negligible.
- Eco-friendly.

6.2. Equipment and Machinery Required for Deployment:

- Membrane casting facilities and a workshop.

6.3. Market Demand of the Product:

- Use of ultrapure water is on continuous increase. Emphasis on indigenous production of such units, which are currently supplied by international players, provides an opportunity for Atma Nirbhar Bharat.

6.4. Resource Required (Raw Material, Energy, Water etc.) for Operationalization of the Technology:

- Ground/surface water.

6.5. Economic Unit Size:

- Depending on the scale of manufacturing, it will be available on request.

6.6. Status of Commercialization of the Technology:

- WO 2014/080427A1; US 2015/0298116A1.
- Technology licensed.
- Not yet commercialized.

**For queries, please write to :****Head,**

Business Development & Information Management CSIR-Central Salt and
Marine Chemical Research Institute (CSIR-CSMCRI), Bhavnagar – 364 002, Gujarat



0278-2567462,
Extn. No.: 7800



kamlesh.csmcri@csir.res.in
bdim.csmcri@csir.res.in



director.csmcri@csir.res.in



<http://www.csmcri.res.in>



TRL

6

**SELF-POWERED MOBILE VAN FOR WATER
PURIFICATION/DESALINATION TO PROVIDE SAFE
POTABLE WATER**

TRL 6

**CSIR- Central Salt and Marine Chemical Research Institute
(CSIR-CSMCRI), Bhavnagar-364 002, Gujarat, India**

1. **Name of CSIR Laboratory:**
CSIR-Central Salt and Marine Chemical Research Institute (CSIR-CSMCRI), Bhavnagar - 364 002, Gujarat.
2. **Name of Technology:**
Self-powered mobile van for water purification/desalination to provide safe potable water.
3. **TRL Level: 6**



Demonstration of the mobile van in CSIR-CSMCRI

4. Preamble

Mobile water desalination and purification plant, running on the engine power of the van itself. It can treat turbid/flood and contaminated water using indigenously developed membrane technology to make the water potable on the spot during natural calamities.

5. Technical Description

- Design, testing methods, installation & commissioning processes of the mobile desalination plant.
- Demonstration of the operation of a mobile desalination plant.

6. Design Details

6.1. Salient Features

- Capacity to desalinate 2000 LPH of brackish water & 500 LPH of two-pass SWRO.
- Two different variants are available.
- The newer design is an improved version of the existing mobile van, with dimensions of 11500 X 2500 X 3300 mm (LXBXH) to 2550 X 1750, keeping the overall power generation & desalination capacity similar & making it viable for reaching different terrain and remote locations smoothly.
- The Indigenous TFC/UF membrane technology applied in the van makes it unique.

- No electricity requirements at the site.
- Eco-friendly.

6.2 Equipment and Machinery Required for Deployment:

- Transmission system, gearbox design, Generator/alternator, pumps, belt conveyors, body fabrication, pressure vessels, electrical panel, solar panel, etc.

6.3 Market Demand of the Product:

- The technology is ready for transfer and can be implemented at a commercial scale.
- The product has high demand in various state governments and the industrial sector.
- Ready to be placed in the E-market.
- A mobile van is an important support system for potable water solutions during crises such as cyclones, floods/drought.

6.4 Resource Required (Raw Material, Energy, Water etc.) for Operationalization of the Technology:

- Compact Van of desired specifications, Membrane, Desalination plant.

6.5 Economic Unit Size:

- Depending on the scale of manufacturing, it will be available on request.

6.6 Status of Commercialization of the Technology:

- IN 2022111055047.
- Not yet done; under process.

7. Technology photos (Field installations)



(1) On field demonstration in villages of Gujarat (2) aftermath of cyclone “Tauktae”



For queries, please write to :

Head,

Business Development & Information Management CSIR-Central Salt and Marine Chemical Research Institute (CSIR-CSMCRI), Bhavnagar – 364 002, Gujarat



0278-2567462,
Extn. No.: 7800



kamlesh.csmcri@csir.res.in
bdim.csmcri@csir.res.in



director.csmcri@csir.res.in



<http://www.csmcri.res.in>



**COMPACT AND AFFORDABLE HAND PUMP
ULTRAFILTRATION SYSTEMS FOR SURFACE & FLOOD
WATER PURIFICATION**

TRL 8

CSIR-Indian Institute of Chemical Technology
(CSIR-IICT), Hyderabad - 500 007, Telangana, India

1. Name of CSIR Laboratory:

**CSIR-Indian Institute of Chemical Technology (CSIR-IICT),
Hyderabad - 500 007, Telangana, India.**

2. Name of Technology:

Compact and affordable hand pump ultrafiltration systems for surface & flood water purification.

3. TRL Level: 8**4. Preamble**

For disaster management and emergency relief operations, a high-flux polyethersulfone-based hand pump-operated UF system has been designed for clarification and disinfection of floodwater. The portable system employs hollow fiber UF membranes (1050 Å) and operates at 1 atm pressure, eliminating dependence on external power sources. Each unit has a capacity of 700 L/h and includes an outlet chlorine cartridge to prevent secondary microbial contamination.

5. Technical Description

Ultrafiltration (UF) is a low-pressure process that uses a centrifugal pump to drive water through hollow fiber membranes with pore sizes around 0.01 µm, effectively clarifying and disinfecting surface water with TDS below 500 ppm. Raw water from lakes, ponds, rivers, or rainwater harvesting is prefiltered through sand, activated carbon, and micron cartridge filters, followed by UV and ozone treatment for microbial safety. A hand-pump-operated UF system, costing about Rs. 1 lakh for a capacity of 700 L/hr, is especially useful during floods and emergencies. These units have been deployed at 25 locations across seven Indian states during major flood and cyclone events, providing safe drinking water to over 200,000 people and reducing the risk of diseases such as cholera, gastroenteritis, jaundice, and typhoid.

6. Design Details**6.1. Salient Features**

- Design and development of hand-operated hollow fiber ultrafiltration membrane systems for surface water treatment.
- Novel high flux polyethersulfone membrane indigenously developed by CSIR-IICT.
- Produces potable water with a high flow rate (700 LPH).
- Smart chlorine cartridge eliminates secondary contamination.
- The highly compact design enables it to be transported to remote villages.
- The unit requires a smaller footprint for installation.

6.2. Equipment and Machinery Required for Deployment:

- The system works instantly once installed.

6.3. Duration to the First Output after Installation:

The system works instantly once installed.

6.4. Is the Product Output Seasonal or Continuous:

Continuous.

6.5. Quality and Stability of the Obtained Product:

The product can handle raw water having a TDS ranging from 100 to 300 ppm. The membrane systems operate stably, achieving efficient water recovery of more than 95% with high-quality water free of disease-causing microbes, turbidity, and bacteria.

6.6. Market Demand of the Product:

There is a substantial market demand for compact, affordable hand-pump ultrafiltration systems, especially in areas that rely on surface or flood-affected water sources. Rural communities, disaster-prone regions, and locations without electricity need simple, low-cost solutions for producing safe drinking water. Government agencies, NGOs, and emergency response programs increasingly prefer such portable, reliable systems for both routine household use and rapid deployment during floods or contamination events. Growing concerns about waterborne diseases and the rising frequency of flood-related water crises are driving demand for these decentralised purification units.

6.7. Resource Required (Raw Material, Energy, Water etc.) for Operationalization of the Technology:

- Flood Water.

6.8. Climatic and Geographical Conditions Required (Temperature, Rainfall, Humidity, Wind, Train, Soil Condition):

The system runs on hand pump.

6.9. Area Footprint of the Process:

10 ft x 5 ft x 3 ft

6.10. Gestation Period of the Project:

A gestation period of 15 to 20 days is sufficient to set up a plant of the required capacity. Before the pilot plant deployment, water analysis for turbidity, bacteria, and TDS is to be conducted.

6.11. Economic Unit Size:

- 700 L/h capacity.

6.12. Indicative Investment:

1 Lakh per unit

6.13. Status of Commercialization of the Technology:

- Ready for commercialization.

7. Technology photos (Field installations)

700 L/H Capacity UF System



Gokak taluk and Ramdurg, Karnataka



Madhubani, Bihar



Installations for Yaas floods at different locations in West Bengal



For queries, please write to :

Head,
Business Development and Research Management (BDRM)
CSIR-Indian Institute of Chemical Technology (CSIR-IICT),
Hyderabad – 500 007, Telangana, India



+91-40-27193992



Dr. S. Sridhar, Chief Scientist



director.iict@csir.res.in



<http://www.iict.res.in>



**COMPACT AND LOW-COST MODULAR RO/NF SYSTEMS
FOR DEFLUORIDATION OF GROUND WATER AND
PURIFICATION OF SURFACE WATER**

TRL 8

CSIR-Indian Institute of Chemical Technology
(CSIR-IICT), Hyderabad - 500 007, Telangana, India

1. Name of CSIR Laboratory

CSIR-Indian Institute of Chemical Technology (CSIR-IICT), Hyderabad - 500 007, Telangana, India.

2. Name of Technology

Compact and low-cost modular RO/NF systems for defluoridation of groundwater and purification of surface water.

3. TRLevel: 8**4. Preamble**

Compact and low-cost modular RO/NF systems offer an effective solution for defluoridation of groundwater and purification of surface water in small hamlets and fluoride-affected remote regions. These moderate-capacity units (100-1000 L/h) remove high TDS, fluoride, suspended solids, hardness, turbidity, and microbes in a single step, producing safe, mineral-rich water with up to 80% recovery. The system is flexible and can be easily converted between RO and nanofiltration modes. Its compact, robust, and low-maintenance design makes it suitable for installation in limited spaces and for portable use.

5. Technical Description

The compact modular RO/NF system treats high-TDS, fluoride-rich, and contaminated groundwater or surface water using interchangeable membrane modules. Operating at 100-1000 L/h with up to 80% recovery, it uses a single feed pump to run one or multiple membranes. Pre-filtration, membrane separation, and GAC post-treatment ensure safe, good-tasting, remineralized water. The unit is portable, robust, low-maintenance, and ideal for small and remote communities.

6. Design Details**6.1. Salient Features**

- The cost-effective moderate capacity RO/NF/UF plant is useful for the treatment of water containing high TDS, fluoride, suspended solids, hardness, turbidity and disease-causing microbes in a single step.
- The plant is very useful in the small hamlets and fluoride affected remote places
- Highly compact, moderate systems of 100 to 1000 L/h capacity enable production of mineral rich water with 80% water recovery
- The unit is flexible and is inter convertible from reverse osmosis to nanofiltration membrane system.
- Easy to use, robust and requires very less space and maintenance and portable in nature.
- The design also has a feasibility to incorporate more than one membrane modules where in a single feed pump is sufficient to build the required feed pressure.
- The taste of the water is enhanced by post treatment using granulated activated carbon filter whereas a provision is made for TDS control in permeate line to remineralize the water.

6.2. Equipment and Machinery Required for Deployment:

- Prefilters (Sand filter, activated carbon column and micron cartridge-based sediment filter), Membranes and modules, Skid, Piping and fittings, UV lamp, Ozonator.

6.3. Duration to the First Output after Installation:

The system works instantaneously once it is installed.

6.4. Is the Product Output Seasonal or Continuous:

Continuous.

6.5. Quality and Stability of the Obtained Product:

The product can handle raw water having a TDS ranging from 100 to 1000 ppm. The membrane systems run stably to achieve efficient product recovery with high quality water free of disease-causing microbes. Physical membrane cleaning and washing can further improve product life.

6.6. Market Demand of the Product:

Techno Economic Comparison of the proposed CSIR-IICT Compact defluoridation membrane unit with market technologies:

Company	Brands	Technology	Cost in Rs.
Aquapuro Equipments Pvt Ltd, Mumbai	RO 250 LPH plant	Pre-filters, sand filter, carbon filter, RO membrane	4,00,000/-
Metro Electronic Lab, Delhi	RO 250 LPH plant	Pre-filters, sand filter, carbon filter, RO membrane	4,00,000/-
Proposed CSIR-IICT Technology	250 L/h	RO/NF, + UV, Ozonation, post carbon filter	1,50,000/-

6.7 Resource Required (Raw Material, Energy, Water, etc.) for operationalization of the technology:

- Ground/Surface Water.

6.8 Climatic and Geographical Conditions Required (Temperature, Rainfall, Humidity, Wind, Train, Soil Condition):

The system runs on electric power with a sufficient raw water source.

6.9 Area Footprint of the Process:

7 m x 6 m x 5 m

6.10 Gestation Period of the Project:

The technology on water purification is fully commercialized. Gestation period of 15 to 20 days is sufficient to setup a plant of required capacity. Before deployment of pilot plant, a detailed water analysis is done to know the raw water characteristics. Based on the impurity level of contaminants in raw water, a membrane system with suitable configuration could be designed and deployed.

6.11 Economic Unit Size:

- 100 LPH capacity plant.

6.12 Indicative Investment:

Please refer to section (7.6)

6.13 Status of Commercialization of the Technology:

- Ready for commercialization.

7. Technology photos (Field installations)

150 L/h capacity

250 L/h capacity

1200 L/h capacity



For queries, please write to :

Head,

Business Development and Research Management (BDRM)
CSIR-Indian Institute of Chemical Technology (CSIR-IICT),
Hyderabad – 500 007, Telangana, India



+91-40-27193992



Dr. S. Sridhar, Chief Scientist



director.iict@csir.res.in



<http://www.iict.res.in>



**ULTRAFILTRATION DRIVEN REVERSE
OSMOSIS SYSTEM
FOR MINERAL ENRICHED DRINKING WATER**

TRL 8

CSIR-Indian Institute of Chemical Technology
(CSIR-IICT), Hyderabad - 500 007, Telangana, India

- 1. Name of CSIR Laboratory**
**CSIR-Indian Institute of Chemical Technology (CSIR-IICT),
Hyderabad - 500 007, Telangana, India.**
- 2. Name of Technology**
Ultrafiltration Driven Reverse Osmosis System for Mineral Enriched Drinking Water.
- 3. TRL Level: 8**

4. Preamble

An integrated ROUF system has been developed for the treatment of surface water and moderate-TDS groundwater contaminated with heavy metals.

5. Technical Description

The system utilises a novel polyurea-based RO membrane that removes heavy metals, dissolved solids, and suspended impurities simultaneously. Integration of RO and UF enables water purification within the nanofiltration range, maintaining both high purity and balanced mineral content. Pretreatment stages include micron cartridge filters and activated carbon filters to remove suspended solids, color, and odor. The RO permeate can be blended with a controlled fraction of UF-treated water to maintain a total dissolved solids (TDS) level of at least 80 ppm, ensuring the presence of essential minerals for human health. In areas affected by fluoride, iron, or arsenic contamination, remineralisation is achieved through the controlled addition of a rock salt and lime mixture. The final UV disinfection stage ensures complete microbial safety and compliance with drinking water quality standards.

6. Design Details

6.1. Salient Features

- IICT developed an integrated RO+UF system to treat surface and moderate-TDS groundwater.
- The polyurea-based RO membrane removes heavy metals and dissolved and suspended solids simultaneously.
- Pretreatment includes micron and activated carbon filters to remove color, odor, and suspended solids.
- Blending of permeate with treated water maintains mineral balance and a minimum TDS of 80 ppm.
- UV treatment ensures complete disinfection.
- The system was jointly developed with Innovative Aqua and installed at the CCMB hostel, Hyd. & industrial biotech park, Jammu, CSIR-IIIM, Jammu, for drinking water supply.

6.2. Equipment and Machinery Required for Deployment:

- Prefilters (Sand filter, activated carbon column and micron cartridge-based sediment filter), Membranes and modules, Skid, Piping and fittings, UV lamp, Ozonator.

6.3. Duration to the First Output after Installation:

The system works instantly once installed.

6.4. Is the Product Output Seasonal or Continuous:

Continuous.

6.5. Quality and Stability of the Obtained Product:

The treated water obtained from the integrated ROUF system exhibits high quality and long-term stability due to its multistage purification and controlled mineral management. The polyurea-based RO membrane effectively removes heavy metals, excess dissolved solids, fluoride, arsenic, iron, and other contaminants, while UF pretreatment and final UV disinfection eliminate suspended particles and microbial impurities. The controlled blending of RO permeate with UF-treated water maintains a stable mineral balance with a minimum TDS of 80 ppm, ensuring the presence of essential minerals and preventing the water from becoming excessively corrosive or aggressive. In areas with specific contamination challenges, the addition of rock salt and lime further enhances remineralisation and chemical stability. Overall, the final product demonstrates consistent clarity, taste, safety, and compliance with drinking water quality standards, with minimal risk of microbial regrowth or chemical instability during storage and distribution.

6.6. Market Demand of the Product:

The market demand for the treated water produced by the integrated ROUF system is strong and steadily increasing, driven by the growing need for safe, reliable drinking water in both rural and urban regions. Many communities face challenges such as heavy metal contamination, high TDS levels, and the presence of fluoride, arsenic, or iron in groundwater and surface water sources, underscoring the need for advanced purification systems that can address multiple pollutants simultaneously. The system's ability to deliver high-quality, mineral-balanced drinking water makes it particularly attractive for households, small communities, institutions, and industries seeking a dependable potable water supply. Additionally, increasing awareness of waterborne diseases, stricter regulatory standards, and the preference for decentralized, low-maintenance purification technologies further strengthen market demand. The product's versatility, cost-effectiveness, and ability to maintain consistent water quality position it well within an expanding market for sustainable, health-focused water treatment solutions.

6.7. Resource Required (Raw Material, Energy, Water, etc.) for operationalization of the technology:

- Groundwater/surface water.

6.8. Climatic and Geographical Conditions Required (Temperature, Rainfall, Humidity, Wind, Train, Soil Condition):

The system runs on electric power with a sufficient raw water source.

6.9. Area Footprint of the Process:

10 ft x 6 ft.

6.10. Gestation Period of the Project:

The technology for water purification is fully commercialized.

6.11. Economic Unit Size:

- 250 L/h capacity.

6.12. Indicative Investment:

Rs. 2.5 lakh.

6.13. Status of Commercialization of the Technology:

- Ready for commercialization.

7. Technology photos (Field installations)

RO+UF integrated water purification system of 250L/h capacity

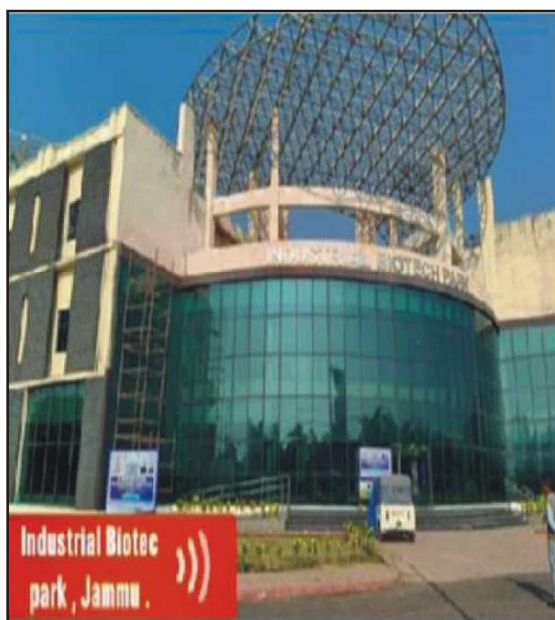

First system installed at industrial biotech park, Jammu



First system installed at industrial biotech park, Jammu



For queries, please write to :

Head,

Business Development and Research Management (BDRM)
CSIR-Indian Institute of Chemical Technology (CSIR-IICT),
Hyderabad – 500 007, Telangana, India



+91-40-27193992



Dr. S. Sridhar, Chief Scientist



director.iict@csir.res.in



<http://www.iict.res.in>

SECTION VI

WATER QUALITY TESTING KIT



PORTABLE WATER ANALYSIS KIT

TRL 8



CSIR-Indian Institute of Toxicology Research
(CSIR-IITR), Lucknow-226020, Uttar Pradesh, India

1. Name of CSIR Laboratory

CSIR-Indian Institute of Toxicology Research (CSIR-IITR),
Lucknow - 226 020, Uttar Pradesh, India.

2. Name of Technology

Portable Water analysis kit.

3. TRL Level: 8**4. Preamble**

Analysis of drinking water for its potability is a tedious process and can only be carried out in laboratories with sufficient facilities. A portable water analysis kit for the bacteriological and chemical analysis of water was developed and patented by CSIR-IITR, which can be used even in rural areas. The kit can quantitatively test for total and faecal coliforms, pH, total dissolved solids, fluoride, iron, nitrate, residual chlorine, sulphate, total hardness, and total alkalinity in water to ensure its safety for drinking purposes.

5. Technical Description

The kit is designed for assessing drinking water quality in remote areas and can be operated by a person with minimal training. The kit is equipped with a colourimeter and an incubator, both adjustable to 37 °C or 44 °C. The kit can perform chemical and bacteriological tests to ensure the safety of drinking water.

5.1. Salient Features

- The kit is very simple to operate and provides quantitative and qualitative results for bacteriological (faecal coliform) and physico-chemical parameters, as per BIS and WHO guidelines for drinking water. The kit is economical and portable with approx. 12 Kg. weight. The kit can be operated on a 1KVA generator in the absence of a 220V electrical supply. The kit is made from indigenous sources.

5.2. Equipment and Machinery Required for Deployment:

- The kit is equipped with a colourimeter and an incubator, both adjustable to 37 °C or 44 °C. The kit can perform chemical and bacteriological tests to ensure the safety of drinking water.

5.3. Duration to the First Output after Installation:

Ready to use.

5.4. Is the Product Output Seasonal or Continuous:

Continuous.

5.5. Quality and Stability of the Obtained Product:

Up to the mark.

5.6. Market Demand of the Product:

Voluminous.

5.7. Resource Required (Raw Material, Energy, Water, etc.) for operationalization of the technology:

- Locally available materials and minor electronic components. The kit is made from indigenous sources.

5.8. Climatic and Geographical Conditions Required (Temperature, Rainfall, Humidity, Wind, Train, Soil Condition):

No environmental constraints for the preparation and running of the test.

5.9. Area Footprint of the Process:

Water quality assessment/ Monitoring bodies.

5.10. Gestation Period of the Project:

NA.

5.11. Economic Unit Size:

- The kit is economical and portable with approx. 12 Kg. weight. A larger version can continuously supply 450 Litres of water/ hour to communities.

5.12. Indicative Investment:

Depends on the production.

5.13. Status of Commercialization of the Technology:

- The technology/ know-how is ready for commercialization.



For queries, please write to :

Director,

CSIR-Indian Institute of Toxicology Research,
31, Vishvigyan Bhawan, MG Marg, Lucknow-226 001,
Uttar Pradesh, India



+91-522-2217497



+91-522-2628227



director.iitr@csir.res.in



<http://www.iitr.res.in>



ARSENIC ESTIMATION FIELD KIT

TRL 8



Field Kit :
Exterior / Interior

CSIR-National Environmental Engineering Research Institute
(CSIR-NEERI), Nagpur - 440020, Maharashtra, India

techniques, such as visible, atomic absorption, and emission spectrometry (1,2). Hydride generation Atomic Absorption Spectrometry (HG-AAS) is one of the most widely used methods for Arsenic estimation due to its high sensitivity, low detection limit, and high selectivity (3,4). Flow-injection hydride generation AAS(5), Graphite furnace AAS(6), inductively coupled plasmaatomic emission spectroscopy, and inductively coupled plasma-mass spectrometer are some of the methods used for the determination of arsenic in the laboratory. These laboratory methods are the most expensive, and they require highly experienced technical staff for their operation and maintenance. Various portable kits are available in the market, but most are qualitative and semi-quantitative in nature. The concept will be further explored to develop a field kit based on the colourimetric principle for precise, accurate estimation of arsenic in potable water.

5. Technical Description

Principle

Arsenic is liberated as arsine (AsH_3) by zinc in an acid solution in a conical flask type arsine generator. The generated arsine is passed through a mercuric bromide test paper. The generated arsine produces a yellow to brown stain on test paper impregnated with mercuric bromide. The stain's developed colour is proportional to the amount of arsenic present.

- Standard Mercuric Bromide stain method: Yellow to Brown to Black
- Eliminates most of the drawbacks observed in the existing kits available in the market
- Easy to carry in the field
(Weight about 1 kg)

6. Design Details

6.1. Salient Features

- Aesthetic, Sturdy, Lightweight
- Free from occupational hazards
- Contains arsenic-free reagents
- Convenient to carry in the field
- Useful for rapid on-site screening of water sources for arsenic levels
- Detection range: 0.01 - 1.0 mg/L Arsenic
- Can conduct 100 tests per kit. The chemicals can be subsequently replenished.
- Precise and accurate at As levels ≥ 50 ppb
- The field kit can be used by anyone who has received basic training in testing the kit. The field kit will be highly useful for NGOs and PHEDs in arsenic-affected areas.

6.2 Equipment and Machinery Required for Deployment:

- Glass assembly comprising an arsine generator, sulfide trap, and trap cover (all having standard glass joint arrangements to prevent any escape of arsenic).
- Two polythene bottles containing Reagent 1 and Reagent 2 (As this is hydrochloric acid and hence, should be filled in the polythene bottle on the day of the field visit).

- One small polythene bottle containing lead acetate solution
- One small plastic bottle containing cotton plugs.
- One small plastic bottle containing HgBr₂ strips (most effective for 1 month)
- One elongated box with colour comparator chart on the top (inside forceps, plastic rod, spatula)
- Adhesive tape
- Tissue paper
- Record pad
- Instructions for Use (in English and Regional Language).

7.3 Status of Commercialization of the Technology:

- Technology know-how was transferred to a firm.



For queries, please write to :

Director,

CSIR-National Environmental Engineering Research Institute
(CSIR-NEERI), Nehru Marg, Nagpur-440020, Maharashtra India.



+91-712-2249999



+91-712-2249900



director.neeri@csir.res.in



<http://www.neeri.res.in>



MULTI-PARAMETER WATER QUALITY MEASUREMENT FIELD TEST KIT

TRL 8



**CSIR-National Environmental Engineering Research Institute
(CSIR-NEERI), Nagpur - 440020, Maharashtra, India**

1. **Name of CSIR Laboratory**
CSIR- National Environmental Engineering Research Institute (CSIR-NEERI), Nagpur - 440 020, Maharashtra, India.
2. **Name of Technology**
Multi parameter Water Quality Measurement Field Test Kit.
3. **TRL Level: 8**



Water quality field testing Kit

4. Preamble

A major constraint in providing safe drinking water to millions of rural residents is the lack of adequate infrastructure for screening and selecting water supply sources, as well as for monitoring contaminant levels to ensure public health safety. Logistical challenges and insufficient water-quality testing facilities hinder the consistent generation of reliable water-quality data, thereby limiting efforts to protect water sources effectively. When contamination occurs, timely and effective water quality testing is essential, as it provides early warning signals that enable interventions to reduce or eliminate undesirable constituents to acceptable levels.

The goal of the water supply programme in rural areas shall be to ensure year-round access to adequate quantities of safe water for all consumers. To many people, water quality means its aesthetic characteristics, such as clarity, colour, taste, and odour. In rural areas, the majority of water quality problems are related to bacterial contamination; however, significant health effects may occur from chemical contamination of water resources. Hence, it is desired that water sources be regularly monitored and surveilled using a sustainable water-quality monitoring system, such as field test kits, to screen a large number of sources. Significant chemical test parameters for which regular monitoring and surveillance shall aim may include Arsenic, Fluoride, Iron, Nitrate, Residual Chlorine, Chloride, Alkalinity, and Hardness.

Firstly, due to resource and time constraints for establishing sufficient numbers of well-equipped water quality testing laboratories, and partly due to the dynamic nature of water quality, there is a

definite place for simplified Water Quality Field Test Kits (WQFTK) within an overall approach to water quality monitoring in the country. WQFTK can conduct initial screening and periodic monitoring of all drinking water sources. Such tests would be relatively inexpensive and could be conducted at the water user level, thereby improving the potential for user community involvement. The results of WQFTK can be supported by detailed analysis of problem sources in district-level laboratories, which are being established throughout the country.

Under the Modified National Rural Water Programme, the issue of Water Quality Monitoring and Surveillance has been given major emphasis. It is suggested that the existing Portable Testing Kits be used for primary detection of chemical and biological contamination across all drinking water sources in villages. Secondly, the govt. of India, under the Water Supply and Sanitation Initiative, is encouraging the use of field test kits for on-site screening and quantification of water supply sources for water quality parameters.

The **Multi-Parameter Water Quality Field Test Kit developed by CSIR-NEERI is useful for the analysis of 8 potential water quality parameters**, viz. Turbidity, pH, Total hardness, Total Alkalinity, Chloride, Residual Chlorine, Iron and Nitrate.

5. Technical Description

Sr. No.	Parameter	Principle
1.	Turbidity	Visual comparison with Sacchi Disc icon
2.	pH	pH strips colour comparison
3.	Total Hardness	Titrimetric
4.	Total Alkalinity	Titrimetric
5.	Chloride	Titrimetric
6.	Residual Chlorine	Visual colour comparison with standard colour chart
7.	Iron	Visual colour comparison with standard colour chart
8.	Nitrate	Visual colour comparison with standard colour chart

6. Design Details

6.1 Salient Features

- Design parameters
 - consistent and reliable results
 - gives accurate results quickly
 - usable and portable for field technicians
 - easy to learn and deploy
- Other design criteria
 - Aesthetics, Sturdy, Lightweight, Free from occupational hazards
 - Rapid on-site quantification of 8 potential water quality parameters
- No significant environmental considerations

6.2 Equipment and Machinery Required for Deployment:

- A small molded box containing test material, reagents and colour comparator charts and convenient to carry in the field.

6.3 Resource Required (Raw Material, Energy, Water etc.) for Operationalization of the Technology:

- Moulded plastic container, Reagents, glassware, visual colour comparator charts, and Instruction manual.

6.4 Economic Unit Size:

- Moulded plastic container : Rs. 500/-
- Reagents for 100 tests : Rs. 1000/-
- Overheads : Rs. 1500/-

6.5 Status of Commercialization of the Technology:

Ready for Commercialisation.



For queries, please write to :

Director,

CSIR-National Environmental Engineering Research Institute
(CSIR-NEERI), Nehru Marg, Nagpur-440020, Maharashtra India.



+91-712-2249999



+91-712-2249900



director.neeri@csir.res.in



<http://www.neeri.res.in>

SECTION VII

IOT ENABLED WATER SERVICE DELIVERY AND MONITORING

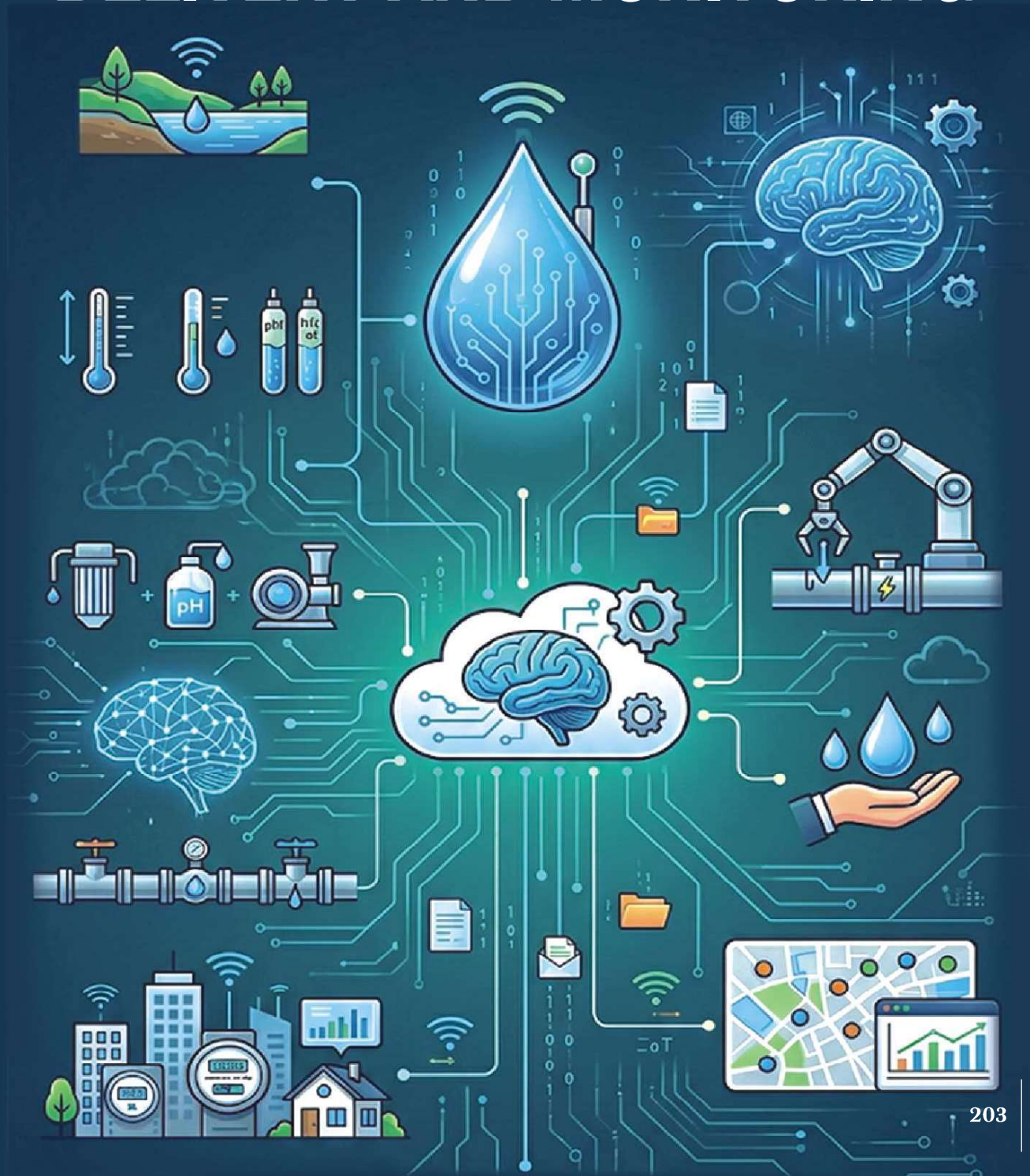

FLUORIDE SENSING SYSTEM (FSS)

TRL 5



CSIR-Central Scientific Instruments Organization
(CSIR-CSIO), Sector-30, Chandigarh 160 030, India

1. Name of CSIR Laboratory:

CSIR- Central Scientific Instruments Organization (CSIR-CSIO), Sector-30, Chandigarh 160 030, India.

2. Name of Technology:

Fluoride Sensing System (FSS).

3. TRL Level: 5**4. Preamble**

Fluorine is a double-edged sword. While essential for strengthening dental enamel against decay, excessive intake through drinking water poses a global health crisis. Most regulatory bodies set the safe limit for fluoride at **0.5 to 1.5 mg/L**. Concentrations beyond this lead to **dental fluorosis** (discoloration and erosion) and **skeletal fluorosis**, a debilitating condition causing bone stiffness and chronic pain.

The Indian Context In India, groundwater contamination is driven by a mix of natural and human factors:

- **Geological & Climatic:** Leaching from fluoride-rich rocks, worsened by low rainfall and high evaporation.
- **Anthropogenic:** Industrial discharge (fertilizers, glass, aluminum), pesticide runoff, and the over-exploitation of groundwater, which concentrates minerals.

States like **Rajasthan, Telangana, Gujarat, Madhya Pradesh, and Assam** are particularly affected, with millions relying on compromised water sources.

A Smarter Solution: CSIR-CSIO's FSS Monitoring is the first line of defense. CSIR-CSIO has developed a **Fluoride Sensing System (FSS)** using advanced optical technology. Unlike traditional methods, this system offers:

- **High Precision:** Accurate detection of even trace levels.

- **Rapid Response:** Instant results for real-time water quality assessment.
- **Portability:** Designed for diverse environmental and industrial applications.

This technology represents a major leap in ensuring global access to safe drinking water and protecting communities from the long-term effects of fluoride toxicity.

5. Technical Description

The CSIO Fluoride Sensing System utilizes a "turn-off-on" fluorescence technique with boron-doped carbon dots to convert fluoride concentration into a linear photocurrent, which an embedded microcontroller then processes and displays as a ppm value on a touch screen.

Table 1: FSS Specifications

SPECIFICATIONS (FLUORIDE SENSOR)	
Feature	Principle: Optical- Fluorescence Light Source: UV-LED; Detector: Photodiode; Sample Cell: Quartz fluorescence cuvette 10 mm path length Sample Volume Required: 1 ml Measurement Mode: Offline
Power Supply	12 VDC
Measuring Range	5 to 50 mg/L
Resolution	5 mg/L
Accuracy	±2 % FS;
Response Time	< 10 Sec
Operating temperature range	20 to 40°C
Body Type	Shell material: ABS thermoplastic polymer
Calibration and Testing	Calibration at the time of installation & periodic maintenance.
Applications	<ul style="list-style-type: none"> • Domestic tank water quality monitoring and control. • Water Fluoridation Monitoring is used to manage dosages and prevent tooth decay. • Fluoride monitoring to avoid overdose to prevent fluorosis. • Environmental Monitoring. • Compliance Monitoring.

6. Design Details

6.1 Electronics design and development

The Fluoride Detection System (FDS) developed by CSIR-CSIO has four major components: Sensing material, Electronics Block, Electronics Software, and Mechanical Assembly (shown in Figure). (MCU), and a Human Machine Interface (HMI) display.

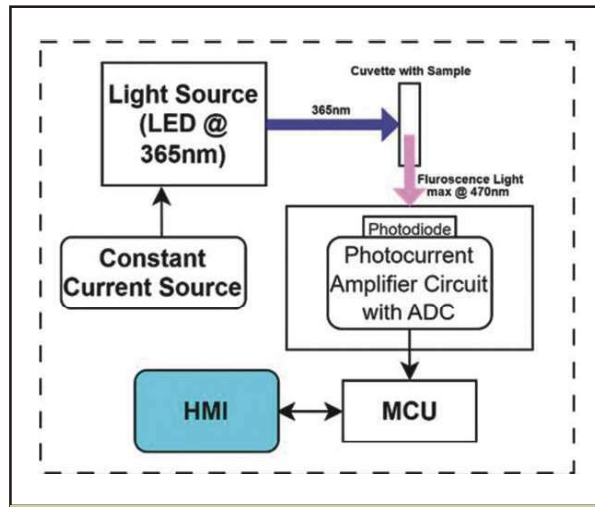

Block Diagram of the Electronics Block in the FDS

6.2 Mechanical Design

The FDS is mostly made with 3D printed with using ABS (Acrylonitrile Butadiene Styrene), which includes both the outer casing and internal cuvette and sensor and PCB holder. These include a lightweight and customisable solution.

This section illustrates the different components required in the manufacturing and assembly of the FDS. These include the drawings of:

- **Internal Assembly.**
- **FDS Chassis**
- **FDS Chassis Base**

6.2.1 Assembly View

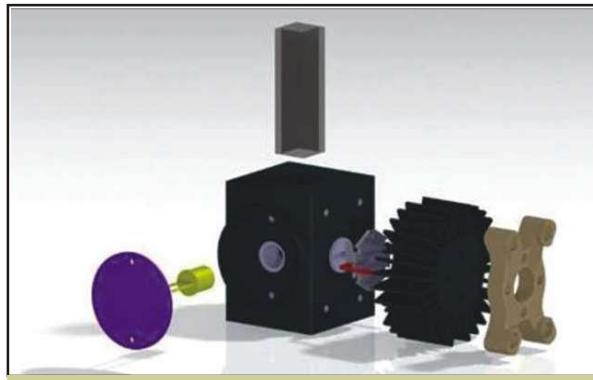

6.2.2 Mechanical Assembly

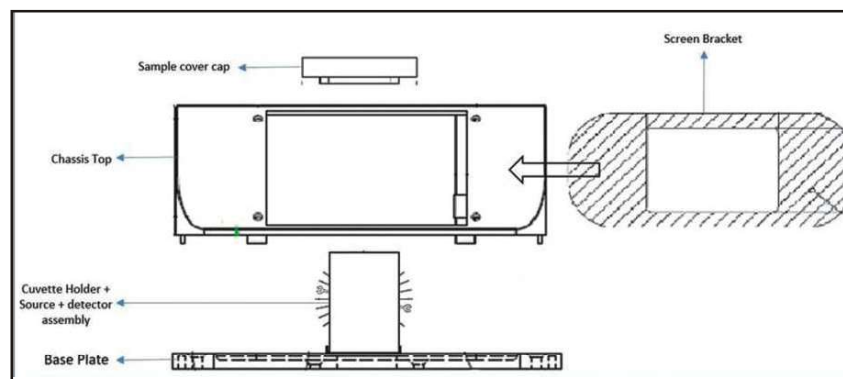

Outer Assembly

6.3 Operation & Maintenance Instructions

6.3.1. Sampling

1. A 1000 μ L, 10mm path length quartz fluorimeter cuvette is used with the FDS.

2. Add 50 μ L BCD-10X to the cuvette

3. Next add 100 μ L Fe-100ppm to the cuvette

Fixed for every

4. The remaining 850 μ L is for the calibration sample/water sample to be tested.

The cuvette will be placed such that the narrow cross-section side should face the light source and the broad one should face the detector side (refer to diagram below).



Cuvette placement and covering

6.3.2 Calibration

- Place The calibration solution of the mentioned concentration.
- Wait till the maximum mV value is reached.
- Press 'Next' and follow the same procedure for other calibration points.

6.3.3 Measurement

The maximum PPM value displayed will indicate the fluoride concentration of that water sample.

6.4 Safety Instructions.

6.4.1 Electricity Safety

- **Power Supply:** Ensure that the power supply you use is rated for the device and is grounded properly.
- **Avoid Water:** Keep the device away from water or other liquids to prevent electrical shorts or damage.
- **Disconnect Power:** Always disconnect the device from the power source before handling or servicing it.

6.4.2 Chemical Handling

- **Protective Gear:** Wear gloves, when handling carbon dots and Iron solution.
- **Proper Storage:** Store reagents in labelled containers in a secure and preferably dark location.
- **Disposal:** Dispose of samples into a sink or drain.

6.4.3 Mechanical Safety

- **Fragile Components:** Handle the device with care, as it may contain fragile components like the cuvette and photodiode.
- **Avoid Drops:** Prevent the device from being dropped or bumped, as this could damage it.
- **Secure Placement:** Place the device on a stable surface to avoid accidental spills or breakage.

6.5 Quality Control and Quality Assurance

QA ensures processes produce quality products. QC inspects products for conformity.

A rigorous QC/QA program involving continuous testing, auditing, and monitoring will be implemented to ensure the FSS meets the highest quality and safety standards.

Inspections:

- Incoming material
- In-process
- Final Product

Norms and Standards:

- Adherence to relevant standards (ISO 9001, FDA, local).
- Implementation quality management systems.

Certifications:

- Obtain necessary certifications (ISO 9001).
- Maintain certifications through audits.

By following these guidelines, licensees can ensure product quality and meet requirements.

6.6 Field Trials and Demonstration

FSS Test Performance

(PPM)			
Sample	Test 1	Test 2	Test 3
0	0	0	0
5	4.08	6.81	6.21
10	10.6	10.9	10.68
15	16.5	17.74	16.94
20	20.30	19.47	20.11
25	25.35	25.35	26.12
30	30.1	30.28	30.14
35	33.59	34.68	34.34
40	40.17	38.41	39.68
45	44.47	46.39	44.28
50	49.47	50.47	51.02

6.7 Beneficiaries & Stakeholders

6.7.1 Primary Beneficiaries

Beneficiaries and stakeholders include water authorities, environmental agencies, and industries for monitoring and compliance, alongside research and healthcare institutions

using the data to improve public health outcomes and ecosystem safety under the guidance of CSIR-CSIO, government bodies, and NGOs.

7.8 Expected Impacts

- **Environmental:** Enhances water quality and protects aquatic ecosystems by identifying and mitigating fluoride pollution sources in real-time.
- **Economic:** Replaces expensive, slow laboratory testing with a cost-effective monitoring solution that helps industries maintain regulatory compliance and operational efficiency.
- **Social:** Safeguards public health by preventing dental and skeletal fluorosis. Reliable monitoring builds community well-being and restores public trust in water safety.
- **Scientific:** Provides high-fidelity data on fluoride distribution and bioaccumulation, driving further innovation in chemical sensing and environmental research.



For queries, please write to :

Scientist and Head,
Business Development Group CSIR-Central Scientific Instruments Organisation
(CSIO), Sector 30-C, Chandigarh-160030, India



+91 172 270 3585



head.bdg@csio.res.in



director@csio.res.in
Dr. Babankumar S. Bansod



<http://www.csio.res.in>
scientist_babankumar@csio.res.in



ON-LINE NITRATE SENSING SYSTEM (ONSS)

TRL 5

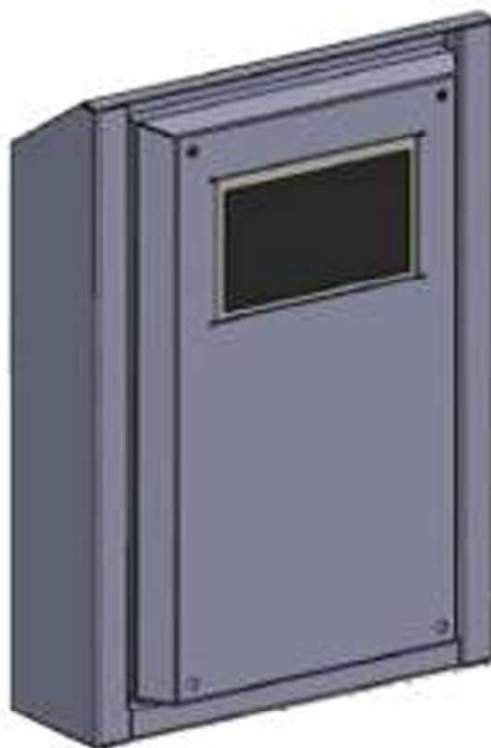

CSIR-Central Scientific Instruments Organization
(CSIR-CSIO), Sector-30, Chandigarh 160 030, India

- 1. Name of CSIR Laboratory:**
CSIR- Central Scientific Instruments Organization (CSIR-CSIO), Sector-30, Chandigarh 160 030, India.
- 2. Name of Technology:**
On-line Nitrate Sensing System (ONSS).
- 3. TRL Level: 5**

4. Preamble

4.1 Importance of Water Quality Sensing

Water is a vital resource, but human activities have severely degraded its quality. Rapid industrialisation, agricultural runoff, and untreated waste have polluted water sources across India, posing serious health risks, especially in rural areas with limited treatment infrastructure. Nitrate contamination, mainly from fertilisers and pesticides, is a major concern. When nitrates seep into groundwater, they can contaminate drinking water, exceeding the permissible limit of 45 ppm. This can cause serious health issues such as methemoglobinemia (blue baby syndrome) in infants and increase cancer risk in adults. Therefore, real-time nitrate monitoring and water-quality sensing systems are crucial to protecting public health, preserving ecosystems, and ensuring sustainable water management in India.

CSIR-Central Scientific Instruments Organisation has developed the nitrate sensing system (NSS) based on UV absorption technology with an integrated IoT. This indigenous device enables real-time water quality monitoring, especially for rural drinking water.

4.2 Applications and Benefits

The Nitrate Sensing System provides water delivery services in rural areas, offering benefits such as real-time nitrate monitoring and continuous water quality assessment. This may be one way of protecting public health against nitrate contamination that would cause more severe health issues associated with methemoglobinemia and cancer. The NSS is cost-effective and portable because it reduces expensive laboratory tests while achieving national water quality standards. It monitors nitrate contamination at an early stage, thus ensuring that the interventions for the water sources safety in rural areas occur at the right time. It also supports programs such as the Jal Jeevan Mission, which fulfils the objective of providing clean and safe water-drinking facilities to families in rural areas.

5. Technical Description

The Nitrate Sensing System (NSS) calculates the nitrate concentration as a function of the optical absorption of UV light. This principle is based on the Beer-Lambert Law, relating absorbance to concentration. In the Beer-Lambert law, the absorbance of light through a medium directly correlates with the concentration of the absorbing species, the path length through which the light passes through the sample, and the molar absorptivity of the substance at a given wavelength. NSS Calibration Operation and Nitrate measuring operation.

The developed Nitrate Sensing System functions in two modes: the first is the measurement mode, which detects and quantifies nitrate concentrations in water samples, and the second is the 3-point calibration mode, where the system is calibrated using standard nitrate solutions of known concentrations to ensure precision and reliability in future measurements. The operating procedures for both modes are described below.

6. Design Details

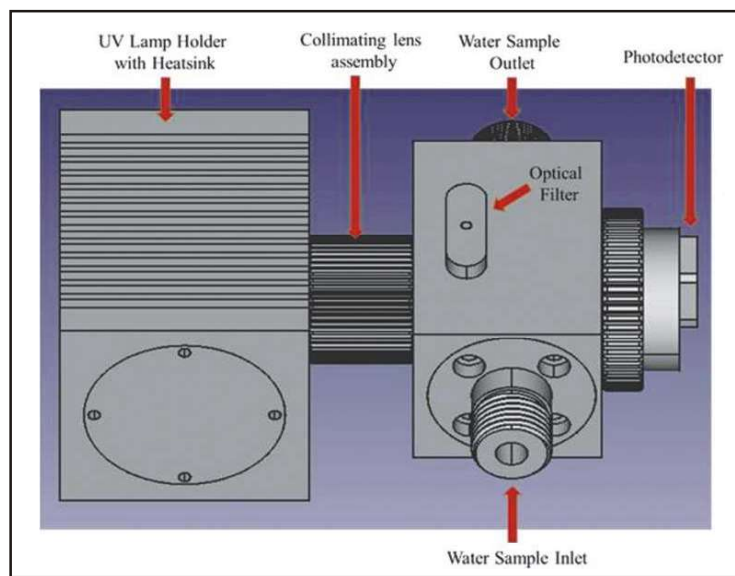

Fabrication design of sensing part

7. Operation & Maintenance Instructions

7.1 Operation and Maintenance Instructions for Nitrate Sensing System

- Fabrication design of sensing part
- Ensure the device is placed in a dry, stable environment.
- Connect the power supply and check all connections, including the UV lamp, solenoid valves, and capacitive touch display.
- Ensure that the sample inlet, calibration inlet, and waste outlet tubes are correctly attached.
- Power on the system by switching on the control unit.
- Use the capacitive touch display to navigate to the desired mode (Measurement or Calibration).
- Select the "Measurement" mode from the touch display.
- Ensure the water sample inlet valve is connected to the source.
- Press the start button on the display to initiate the measurement process.
- The system will automatically control the sample intake, and the UV lamp will operate to determine the nitrate concentration.
- View real-time nitrate concentration results on the touch display. The results will also be logged and uploaded to the cloud.
- Switch to the "Calibration" mode from the display.

- Prepare standard nitrate solutions for calibration.
- The system will prompt for three standard concentrations (3-point calibration).
- The calibration solution is pumped into the cuvette by opening the calibration inlet valve while the sample inlet valve is closed.
- The UV lamp will operate, and the system will record responses for each standard solution to establish a calibration curve.
- Complete the calibration cycle as per the display prompts.

7.2 Maintenance Guidelines

- Ensure the device is placed in a dry, stable environment.
- Connect the power supply and check all connections, including the UV lamp, solenoid valves, and capacitive touch display.
- Ensure that the sample inlet, calibration inlet, and waste outlet tubes are correctly attached.
- Power on the system by switching on the control unit.
- Use the capacitive touch display to navigate to the desired mode (Measurement or Calibration).
- Select the "Measurement" mode from the touch display.
- Ensure the water sample inlet valve is connected to the source.
- Press the start button on the display to initiate the measurement process.
- The system will automatically control the sample intake, and the UV lamp will operate to determine the nitrate concentration.
- View real-time nitrate concentration results on the touch display. The results will also be logged and uploaded to the cloud.
- Switch to the "Calibration" mode from the display.
- Prepare standard nitrate solutions for calibration.
- The system will prompt for three standard concentrations (3-point calibration).
- The calibration solution is pumped into the cuvette by opening the calibration inlet valve while the sample inlet valve is closed.
- The UV lamp will operate, and the system will record responses for each standard solution to establish a calibration curve.
- Complete the calibration cycle as per the display prompts.

7.3. Safety Instructions

7.3.1. Safety Instructions for Nitrate Sensing System(NSS)

- Always operate the system in a well-ventilated, dry environment to avoid electrical hazards.
- Do not expose the device to excessive moisture or extreme temperatures.
- Ensure proper grounding of the electrical components to avoid electric shocks.
- Keep the system away from flammable materials.
- UV light can be harmful to eyes and skin. Avoid direct exposure to the UV light source.
- Ensure that the UV lamp housing is securely closed during operation.
- Wear protective eyewear and clothing when servicing the UV lamp.
- Always ensure the system is powered off before performing any maintenance or adjustments.

- Inspect power cords and connections regularly for wear and tear to prevent electrical hazards.
- Avoid spilling liquids near the power supply or other electrical components.
- Handle water samples with care, especially if they are suspected of being contaminated.
- Properly seal and store all samples after measurements to prevent spills or contamination

7.4. Quality Control and Quality Assurance

To ensure that the licensed Nitrate Sensing System (NSS) technology/product conforms to the documented specifications and requirements, the following QA/QC checklist, points, requirements, and stepwise procedures are outlined. These guidelines cover inspection stages, testing protocols.

7.5. Beneficiaries & Stakeholders

7.5.1 Beneficiaries and Stakeholders

- Government of India
- Municipal bodies
- Ministry of Jal Shakti
- Rural Panchayat / Local Bodies
- Manufacturing Industries

7.5.2 Proposed area of the applications

- **Village-Level Water Treatment Plants:** Can integrate it into water treatment plants to continuously monitor nitrate content in incoming water, ensuring treated water meets national drinking water standards.
- **Piped Water Supply Schemes:** To monitor nitrate ion levels in distribution points under schemes like Jal Jeevan Mission throughout the supply chain, especially in remote and rural areas.

8. Expected Impacts

8.1 Expected Impact of NSS

- The Nitrate Sensing System (NSS) can greatly contribute to the impact of the Jal Jeevan Mission by improving the quality of monitoring of water, whereby the concentration of nitrates will be directly measured instantaneously and in situ in rural sources of drinking water so that the safe drinking standard will be ensured.
- **Early detection of contamination** is one of the several positive impacts of NSS. Since it continuously monitors, it will note the presence of nitrate contamination and intervene before untimely treatment leads to health risks such as methemoglobinemia and other waterborne diseases. This means that public health will be upheld because the NSS will keep the levels of nitrate within safe limits and directly influence the health conditions and well-being among the rural populations where high agricultural runoff is common.
- **Enables the decision-making process:** The system will avail information to local authorities and stakeholders concerning the state of the water that is treated and managed, thereby enabling them in making the best decision regarding management and resource allocation.

- Nitrate level monitoring supported by NSS enables sustainable management of water resources without compromising the quality of water.
- **Cost-Effective Solution:** It is a cost-effective design, making NSS accessible for large-scale deployment that reduces the overall cost of maintaining safe drinking water standards in rural areas all over India.
- **Collaborates with Government Targets:** NSS collaborates with the broader objective of Jal Jeevan Mission, wherein clean, safe, and reliable drinking water will be provided to every household, further aiding the increase in achievement of the mission's targets.



For queries, please write to :

Scientist and Head

Business Development Group CSIR-Central Scientific Instruments Organisation (CSIO), Sector 30-C, Chandigarh-160030, India



+91 172 270 3585



head.bdg@csio.res.in



director@csio.res.in



<http://www.csio.res.in>

Dr. Babankumar S. Bansod

scientist_babankumar@csio.res.in



TURBIDITY SENSING SYSTEM (TSS)

TRL 5



CSIR-Central Scientific Instruments Organization
(CSIR-CSIO), Sector-30, Chandigarh 160 030, India

- 1. Name of CSIR Laboratory:**
CSIR-Central Scientific Instruments Organization (CSIR-CSIO), Sector-30, Chandigarh 160 030, India.
- 2. Name of Technology:**
Turbidity Sensing System (TSS).
- 3. TRL Level: 5**

4. Preamble

Turbidity sensing is essential for monitoring water quality, especially in rural areas where water systems are more vulnerable to contamination. High turbidity indicates the presence of suspended particles, microorganisms, or pollutants, which can pose health risks if untreated. Turbidity refers to the scattering of light in water, reflecting its clarity cloudy water has high turbidity, while clear water has low turbidity. It is commonly caused by particles like silt, clay, organic matter, and microbes. Monitoring turbidity is crucial to ensuring safe drinking water, as it can signal the presence of harmful contaminants and help water treatment systems effectively remove pollutants and pathogens.

CSIR-Central Scientific Instruments Organisation has designed an advanced turbidity sensing system based on the nephelometric principle that measures the scattered light intensity of an angle 90° by suspended particles within Water. This system can operate both as a standalone device and as part of an online monitoring network for water quality in rural pipe-based distribution systems. This sensing system can integrate with Internet of Things (IoT) capabilities and will create scopes for real-time data acquisition of water turbidity with continuous remote monitoring possibilities.

5. Technical Description

5.1 Sensing Principle

The Indigenous-developed Turbidity Sensing System employs the nephelometric method to measure Turbidity by analysing the light scattered by particles suspended in a fluid. This technique, derived from "nephelometry," quantifies particle concentration in liquids by assessing the intensity of scattered light. When a light source illuminates the sample, the particles in the fluid scatter the light in various directions. Typically positioned at a specific angle, a detector measures this scattered light to determine turbidity levels, usually expressed in Nephelometric Turbidity Units (NTU). Nephelometric methods are widely used in water quality monitoring and environmental testing, offering a rapid and reliable assessment of water clarity and potential contaminants.

5.2 Operations/Workflow Turbidity Sensing System

- Turbidity Sensing starts with light emission. A light source, such as an LED, sends light through a borosilicate glass chamber holding the water sample. As it travels through the Water, suspended particles scatter this light, and the degree of scattering depends on the mass and size of these suspended particles. It captures the scattered light at an angle in a photodetector and changes it into an analogue signal corresponding to the turbidity level. This is taken by the 16-bit

ADC, which is converted into an analysed digital format. Then, the Arduino Nano processes the digital data, applies calibration factors, and derives the Turbidity in Nephelometric Turbidity Units.

- While designed to provide output in real-time data, the system also calculates and gives the resultant turbidity value with a local screen. This accuracy is further ascertained by its routine switching into calibration mode, wherein predefined calibration solutions or standards are inputted to ensure sensor stability. It simply means that reliable and accurate turbidity readings are obtained with the system after considerable periods.

5.3 Specifications of Turbidity Sensing System

S. No.	Parameters	Specifications
1.	Turbidity Range	1-1000 NTU (Automatically)
2.	Accuracy	±2% of reading for 0 to100 NTU; ± 5% of reading for 100 to1000 NTU.
3.	Resolution	0.1 NTU (0–99.9 NTU) 1NTU (100–1000 NTU)
4.	Response Time	< 6 seconds for a full step change
5.	Calibration Standards	0.12 NTU; 10 NTU; 100 NTU; 1000 NTU
6.	Light Source	Infrared-emitting diode (850 nm wavelength)
7.	Detector	Photodiode
8.	Stray Light	< 0.02 NTU
9.	Sample Cell	Borosilicate glass with screw caps, fill line and indexing mark.
10.	Sample Volume Required	10 ml
11.	Sample Temp.	0°C to 50°C (32°F to 122°F)
12.	Power Supply	12V DC
13.	Enclosure Type	ABS Plastic

6. Design Details

The Turbidity Sensing System (TSS) developed by CSIR-CSIO has the following major components: Electronics Block, Electronics Software, and Mechanical Assembly.

6.1 Electronics Design and Development

The Turbidity Sensing System PCB circuit schematic, integrates and interfaces various components essential for device operation, including a constant current source, light source, a single PCB containing a photodiode followed by a photocurrent amplification circuit connected to an analogue-to-digital converter (ADC) for digitised voltage measurements, a microcontroller unit (MCU), and a human-machine interface (HMI) display.

6.2 Mechanical Fabrication

The TSS prototype enclosure is 3D printed using ABS (Acrylonitrile Butadiene Styrene), including

the outer casing, internal cuvette, sensor, and PCB holder. These include a lightweight and customisable solution.

6.2.1 Fabricated TSS Prototype

7. Operation & Maintenance Instructions

TSS Basic Operations

1. The graphic user interface of the turbidity meter has self-explanatory menus with easy user interactions. In the main menu, you can select mode: it has two buttons M. Mode and Calibration.

2. By pressing the M. Mode button, you directly enter the measurement window, where you can read turbidity readings of samples under measurement. (Note: The system runs on old calibration by directly entering into measurement mode. For more accurate results, you can calibrate the system before use).

3. By pressing the Calibration button, you will enter into calibration mode. First, it will ask for a 0.12 NTU calibration point. The instrument picks the calibration value for the given standard solution. The Calibration window has two buttons. The save button is used to store the calibration value, and the Back button is used to go back to the main menu. So similarly, when you complete the calibration, the last window will show up in which the system is calibrated displayed.

4. So, by pressing M. Mode from the last window of the calibration routine, you can enter into measurement mode, where continuous readings of Turbidity are displayed within 6- second intervals.

Note: For best storage conditions, place the solution in a dark bottle and store it in a fresh and dark place.

Attention: For Turbidity, this instrument must be calibrated using Formazine Standard and cannot be calibrated using Polymers.

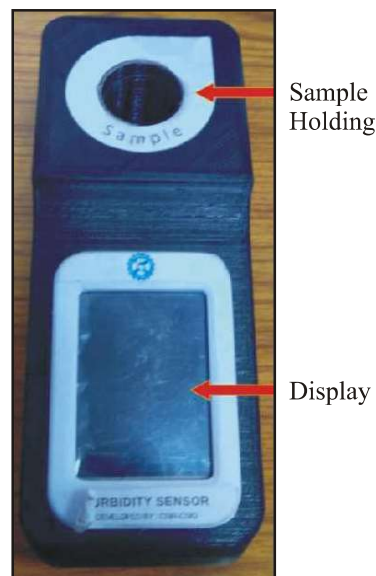

8. Safety Instructions

8.1 Electrical Safety

To ensure electrical safety for the Turbidity Sensing System (TSS), the following guidelines should be followed.

8.2 General Safety

- Ensure that the power supply is properly rated for the Arduino Nano and other components in the TSS setup.
- The power supply should be grounded and provide a stable voltage to avoid any electrical issues or surges.
- Use appropriate over-current protection (such as fuses) to safeguard the system from short circuits or overloads.

8.3 Avoid Water

- Keep the TSS and its components away from Water or other liquids to prevent accidental short circuits or damage.

- Ensure proper insulation for any exposed wiring or circuitry, especially in environments where moisture is present.

8.4 Disconnect Power

- Always disconnect the TSS from the power supply before handling or servicing any system part, including sensor calibration or component replacements.
- Ensure that capacitors and other energy-storing components have fully discharged before working on the system to avoid electrical shock.

8.5 Mechanical Safety

To ensure mechanical safety when working with the Turbidity Sensing System (TSS), follow these essential guidelines.

8.6 Fragile Components

- Handle the TSS carefully, especially components like the optical sensors and cuvettes, which may be fragile.
- Take extra care when inserting or removing the cuvette to avoid cracking or damaging the sensor components.

8.7 Avoid Drops

- Prevent the system from being dropped or bumped, as it can damage sensitive parts like the Arduino Nano, the Nextion Display, or the sensors.
- Use a protective housing or casing to support the system's fragile components.

8.8 Secure Placement

- Place the TSS on a stable surface to avoid accidental movement, spills, or breakage.
- Ensure that any attached wires or connections are not left dangling, possibly leading to accidental pulling or tipping over the system.

9. Quality Control and Quality Assurance

Quality Control (QC) and Quality Assurance (QA) for the Turbidity Sensing System.

9.1 Quality Assurance (QA)

Quality Assurance refers to the systematic processes and procedures implemented to ensure that the Turbidity Sensing System (TSS) consistently meets its design and functional requirements. The primary focus of QA is on process-oriented activities that help prevent issues during the design, development, and manufacturing stages.

QA measures for the TSS include,

- Ensure the TSS is designed according to the required standards, and components like the Arduino Nano, Nextion Display, and sensors are chosen based on quality, reliability, and compatibility.
- All materials, from electronic components to structural parts, should be sourced from verified suppliers, ensuring adherence to quality Specifications like electrical performance, durability, and environmental resistance.

Maintain standard operating procedures (SOPs) during TSS assembly, calibration, and testing to guarantee consistency.

- Keep detailed documentation of the design, schematics, software codes, calibration procedures, and any updates or modifications made during development.
- Ensure that personnel building and testing the TSS are well-trained in assembly, calibration, and safety procedures to avoid errors affecting system quality.

9.2 Quality Control (QC)

Quality Control is the process of testing the system and its components to ensure that they meet the specified standards and operate as intended. QC involves inspecting, testing, and verifying the outputs of the TSS to ensure compliance with quality standards.

Key QC measures for the TSS include,

- Test individual components, such as sensors, solenoid valves, and the Arduino Nano, before integrating them into the system. Ensure each component meets the required performance standards (e.g., accuracy, response time).
- Regularly inspect the TSS during and after assembly to verify that the components are securely placed, connections are stable, and the wiring is correct.
- Calibrate the TSS by running known turbidity standards and ensuring the system produces accurate readings. Regularly recalibrate the sensors to maintain performance over time. Perform comprehensive tests of the fully assembled TSS to ensure it functions as expected under different environmental and sample conditions. Ensure that the Nextion Display accurately shows real-time data.
- Track any errors or malfunctions during system testing. Implement corrective actions such as adjusting sensor placement, recalibrating, or software debugging.
- Stress-test the system to evaluate its reliability under extended operation. Simulate environmental conditions that the TSS might encounter to ensure robust performance.

10. Beneficiaries & Stakeholders

The Turbidity Sensing System offers significant benefits across various sectors, particularly in water quality monitoring and management. Here are some beneficiaries and proposed areas of application.

- Government of India
- Ministry of Jal Shakti
- Municipal Institutions/ Other Water Supply Departments
- Wastewater Treatment Plants
- Village and Block Level Administration; Village Water Supply Schemes
- Educational and Research Institutions
- Health and Sanitation NGOs/Environmental Agencies
- Industrial Sector

11. Expected Impacts

Expected Impacts of the Turbidity Sensing System

11.1. Impact on Industry

- TSS provides inexpensive in-situ turbidity assessment, helping to regulate water quality for

industrial uses such as food processing, water treatment, and medicine.

- By enforcing the effluent's turbidity level, preventing fines, and shielding natural water sources from contamination, TSS can help enterprises meet environmental criteria.
- Any sector whose productivity is dependent on water resources benefits from automatic monitoring as it lowers labour costs and improves operational efficiency.

11.2 Immediate Advantages to the Country or Society

- Lowers the risk of waterborne illnesses for millions by ensuring clean Water in municipal supplies, particularly in rural and neglected regions.
- It would improve sanitation, safe drinking water, and water quality for the entire country, making it consistent with national programs like Namami Gange, Swachh Bharat Mission, and National Jal Jeevan Mission.
- It contributes to water security and sustainable management at the local level by monitoring rural regions' local water bodies.

11.3 Environmental Benefit

- The TSS monitors and controls water pollution by ensuring natural water bodies, including rivers, lakes, and groundwater, are free from excess Turbidity from industrial and domestic effluent.
- Healthy aquatic ecosystems involve clean Water, which thus facilitates higher biodiversity.
- Continuous monitoring of wastewater discharge helps industries to reduce the levels of pollutants, thus lowering the overall environmental footprint.

11.4 Economic Impact

- The cost of developing a TSS is much lower than that of expensive water monitoring systems. It is, therefore, accessible to small industries, municipal water authorities, and rural communities.
- Continuous monitoring causes no water quality-related issues' downtime; thus, industries become more productive and their operations more efficient.
- TSS will be deployed and maintained in several sectors. Thus, the system will create employment opportunities by monitoring and analysing data and managing systems. This effect will particularly be felt in rural areas compared to towns and cities.



For queries, please write to :

Scientist and Head

Business Development Group CSIR-Central Scientific Instruments Organisation (CSIO), Sector 30-C, Chandigarh-160030, India



+91 172 270 3585



head.bdg@csio.res.in



director@csio.res.in



<http://www.csio.res.in>

Dr. Babankumar S. Bansod

scientist_babankumar@csio.res.in



TRL
5

Jal-IoT

TRL 5



CSIR-Central Scientific Instruments Organization
(CSIR-CSIO), Sector-30, Chandigarh 160 030, India

1. **Name of CSIR Laboratory:**
CSIR-Central Scientific Instruments Organization (CSIR-CSIO), Sector-30, Chandigarh 160 030, India.
2. **Name of Technology:**
Jal-IoT.
3. **TRL Level: 5**

4. Preamble

The JAL-IoT system, developed by CSIR-Central Scientific Instruments Organisation, is a versatile and innovative Internet of Things (IoT) platform designed to address water resource monitoring and management challenges, particularly focused on delivering drinking water to rural populations. As a part of the National Jal Jeevan Mission, it aims to ensure the efficient, real-time use of water resources by providing continuous monitoring, data collection, and informed decision-making.

The JAL-IoT system functions as both a node and a gateway, and is lauded for its flexibility in interfacing with a wide range of sensor types, including 4-20mA analog sensors and Modbus/RS485 digital interfaces which making it suitable for numerous applications. Capable of monitoring key parameters such as water quality, flow, pressure, and environmental conditions, it enhances rural development efforts and promotes good governance.

This is Equipped with built-in communication modules, battery power supply options, and an extended, scalable design, the JAL-IoT system is built to perform reliably in the harsh conditions of remote areas. The integration of IoT intelligence with communication systems ensures efficient construction and operations of water delivery systems, allowing for safe and reliable water quality monitoring and management for all.

The system's ability to integrate a wide range of sensors and IoT-based data management provides an efficient and scalable solution for safeguarding rpublic health and improving resource management through enhanced monitoring and real-time decision-making.

This report outlines the technical specifications, capabilities, and potential applications of the JAL-IoT device. With advanced power management features and support for a wide range of sensors, the JAL-IoT offers a robust and adaptable solution for industrial water resource-related IoT applications. Its flexibility and reliability make it suitable for diverse environments, ensuring efficient monitoring and management of water quality, distribution, and usage in both urban and rural settings.

5. Technical Description

The JAL IoT device is a versatile, industrial-grade solution designed to interface with a wide range of sensors using 4-20mA analog current loops and Modbus/RS485 digital protocols. It integrates seamlessly with different types of sensors, allowing efficient data acquisition, monitoring, and control in IoT applications. Additionally, it offers flexible power supply options capable of driving

sensors and the IoT device itself, making it a comprehensive solution for industrial, environmental, and smart infrastructure systems.

6. Salient Features

S. No.	Parameter	Description
1.	Input Voltage	9-30 VDC (wide input range to adapt to industrial power standards)
2.	Sensor Interfaces	4-20mA Current Loop, Modbus RTU/RS485
3.	Supported Sensors	Analog sensors (e.g., temperature, pressure, humidity) via 4-20mA, and digital sensors via Modbus/RS485
4.	Power Output for Sensors	12V (for powering Modbus sensors or other industrial-grade devices), 5V (for smaller IoT sensors or low-power devices)
5.	Communication Protocols	MQTT, HTTP, TCP/IP for IoT data transmission
6.	Data Rate	Up to 115200 bps (RS485 interface)
7.	Mounting Options	DIN Rail, Wall Mount
8.	Operating Temperature	20°C to 50°C
9.	Enclosure	IP65-rated for protection against dust and water ingress, suitable for harsh industrial environments
10.	Connectivity	Cellular (4G-LTE), Wi-Fi (depending on the configuration)
11.	Storage	MicroSD slot for local data logging or backup
12.	Application	Node and Gateway

6. Design Details

The Jal-IoT developed by CSIR-CSIO has the following major components: Electronics Block, and Mechanical Assembly.

Electronics Design and Development:

The developed Jal-IoT PCB circuit schematic, as shown in Figure 3, integrates and interfaces various essential components for device operation, including power regulators, a Battery Management System (BMS) for battery charging and gauging, an SD card for data storage, a microcontroller (ESP32) for processing, a Real-Time Clock (RTC) for accurate timekeeping, and a Human-Machine Interface (HMI) display for user interaction. This design begins with defining a robust system architecture that ensures seamless operation among these components. Careful selection and integration of sensors (such as turbidity, nitrate, and flow sensors) are crucial, alongside the implementation of efficient communication protocols to facilitate long-range data

transmission and real-time cloud communication. A strong focus on power management is vital, incorporating the BMS to monitor rechargeable batteries and optimize power consumption for reliable performance in remote settings. Additionally, developing a user-friendly interface for real-time data visualization and alerts is essential for end-users. Prototyping and rigorous testing under real-world conditions are performed to validate the system's performance and reliability while ensuring compliance with relevant environmental and safety standards.

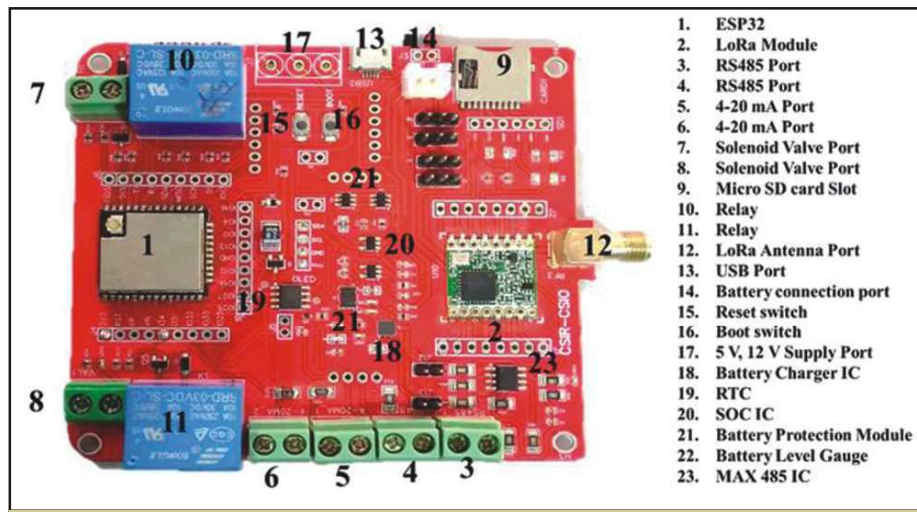

Figure: Photograph of Jal-IoT PCB with components details

Jal-IoT mechanical design (Enclosure) and assembly

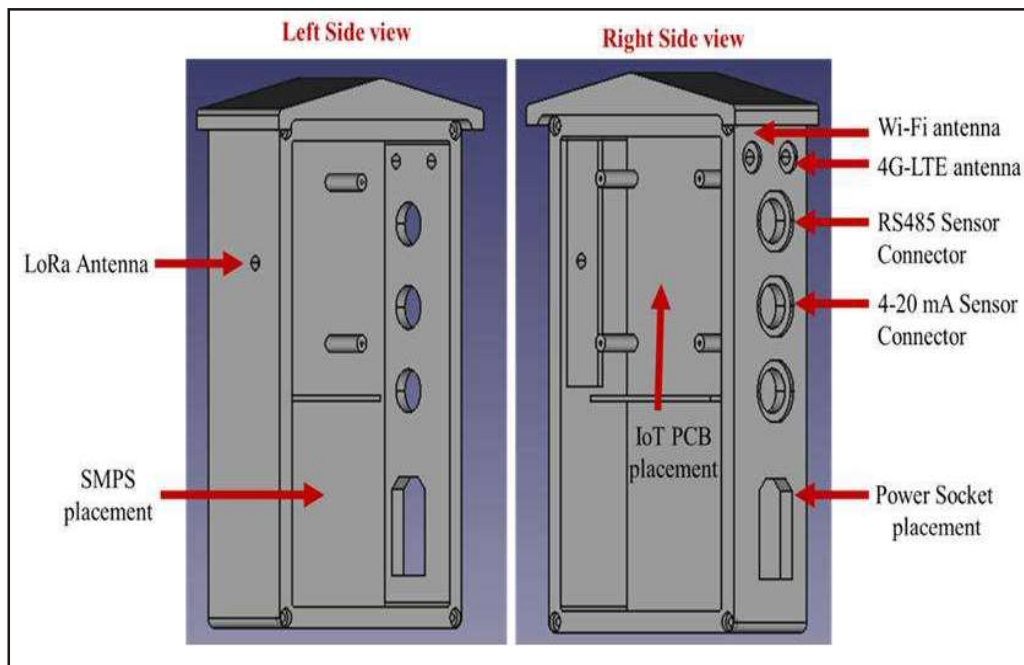

Figure: Fabrication Design of Jal-IoT prototype Enclosure

7. Operation & Maintenance Instructions

The Jal-IoT system is designed to functions both as a node and a gateway, enhancing its versatility in various deployment scenarios. This dual functionality allows the system to effectively monitor and manage water services in rural areas, where reliable connectivity is often a challenge.

The JAL-IoT system operates through a series of basic functions aimed at monitoring and managing water quality in remote areas. Its core operations begin with signal acquisition, where various sensors measure parameters such as turbidity, nitrate levels, and flow rate. The sensors provide both digital and analog signals, which are processed by the ESP32 microcontroller. After data is collected and converted into usable formats, it undergoes real-time processing to ensure accuracy and apply calibration settings.

7.1 Node and Gateway Functionality

- As a node, the Jal-IoT system can collect data from various sensors, such as water quality and flow meters, facilitating real-time monitoring of water services.
As a gateway, it aggregates data from multiple nodes and facilitates communication between them and external networks. This ensures that information is efficiently relayed to central systems for analysis and action.

7.2 Communication Capabilities

Jal-IoT system have two modes of communication

- The Jal-IoT system is equipped with radio communication capabilities. This is particularly useful in remote areas where cellular networks may not be available. The radio communication allows the system to establish connections with nearby nodes or devices without relying on cellular infrastructure.
- When cellular communication is available, the system can seamlessly switch to use cellular networks, ensuring data is transmitted reliably.

7.3 Data Transmission and Visualisation

- The data collected by the Jal-IoT system is sent to the nearest available network point when cellular communication in node is not feasible. This ensures continuous data collection and monitoring.
- Once connected to a network, the data is uploaded to the cloud, allowing for real-time access and analysis. This cloud-based approach enables stakeholders to monitor water service parameters remotely, facilitating timely interventions.
- The system also supports user monitoring through a Human-Machine Interface (HMI) display or mobile application, allowing real-time data representation, historical trend analysis, and alerts for water quality issues. Its energy-efficient design, powered by a battery management system, ensures continuous operation, even in remote and off-grid locations.



Figure: Local Dashboard (Display on Jal-IoT)

7.4. Operational Efficiency

- By utilizing both node and gateway capabilities, the Jal-IoT system optimizes resource usage and enhances the reliability of data collection.
- The system is designed to ensure that data is transmitted even in challenging environments, thereby maintaining the integrity of monitoring processes.

7.5 Safety Instructions

To ensure electrical safety for the Jal-IoT (TSS), the following guidelines should be followed.

Power Supply

- Ensure that the power supply is properly rated with the used components in the Jal-IoT setup.
- Ensure that all electrical components are installed according to local electrical codes and standards. Use appropriate voltage ratings and fuses to prevent overloading.
- The power supply should be grounded and provide a stable voltage to avoid any electrical issues or surges.
- Use appropriate over-current protection (such as fuses) to safeguard the system from short circuits or overloads.
- Always disconnect the system from the main power supply before handling or servicing any system part, including sensor calibration or component replacements.
- Ensure that capacitors and other energy-storing components have fully discharged before working on the system to avoid electrical shock.

Avoid Water

- Keep the Jal-IoT and its components away from Water or other liquids to prevent accidental short circuits or damage.
- Ensure proper insulation for any exposed wiring or circuitry, especially in environments where moisture is present.

Installation Safety

- Before installation, conduct a site assessment to identify potential hazards (e.g., unstable ground, electrical lines) and take precautions to mitigate risks.
- Ensure that all equipment is securely mounted to prevent accidents or equipment damage due to environmental factors (e.g., wind, flooding).

Avoid Drops

- Prevent the system from being dropped or bumped, as it can damage sensitive parts like the controller, the Nextion Display, or the sensors.
- Use a protective housing or casing to support the system's fragile components.

8. Quality Control and Quality Assurance

Quality Control (QC) for the Jal-IoT system involves a systematic process of testing the system and its components to ensure that they meet specified standards and operate as intended. QC focuses on

inspecting, testing, and verifying the outputs of the Jal-IoT system to ensure compliance with established quality standards.

QC measures for the Jal-IoT include

- Conduct thorough inspections of all hardware and software components before integration. This includes verifying the quality and specifications of sensors, communication modules, and other critical parts to ensure they meet design requirements.
- Perform functional tests to ensure that each component of the Jal-IoT system operates correctly and fulfills its intended purpose. This includes testing individual sensors for accuracy and responsiveness in real-time data collection.
- After individual components have been tested, perform integration testing to verify that all system components work together seamlessly. This includes assessing data flow between nodes, gateways, and cloud services to ensure cohesive functionality.
- Assess the overall performance of the Jal-IoT system under various operating conditions. This involves evaluating factors such as response times, data accuracy, and system reliability to ensure that the system meets performance benchmarks.
- Conduct field tests in real-world environments to validate the system's performance under actual operational conditions. This helps identify any potential issues that may not have been apparent during lab testing.
- Ensure that the Jal-IoT system complies with relevant quality standards and regulations governing water quality monitoring. This includes adherence to safety, environmental, and operational guidelines.
- Regularly verify the accuracy and reliability of the data collected by the Jal-IoT system. Implement procedures for cross-checking data with established benchmarks or standards to ensure consistency.
- Establish a clear protocol for identifying, documenting, and addressing any issues discovered during QC processes. This includes a systematic approach to corrective actions to prevent recurrence.
- Use feedback from QC activities to inform continuous improvement efforts. Analyzing trends in defects or performance issues can guide future enhancements to the Jal-IoT system.

9. Field Trials and Demonstration

The Jal-IoT system has been deployed at a CSIO pilot site to measure its performance and other parameters, ensuring its effectiveness in real-world applications. This deployment enables comprehensive assessment and validation of the system's capabilities in monitoring water quality and service delivery. A photograph of the installation is also presented in Figure, showcasing the system setup in the field.



Field trials and demonstrations of the Jal-IoT system in real-world settings systematically assess the system's functionality, gather user feedback, and address operational challenges. This process can lead to further improvements and enhancements, ensuring that the system evolves to meet practical needs more effectively and operates efficiently in diverse conditions for water quality monitoring and management.

10. Beneficiaries & Stakeholders

The Jal-IoT System offers significant benefits across various sectors, particularly in water quality monitoring and management. Some beneficiaries are listed here,

- Government of India
- Ministry of Jal Shakti
- Municipal Institutions/Other water supply departments
- Wastewater Treatment Plants
- Village and Block Level Administration; Village Water Supply Schemes
- Educational and Research Institutions
- Health and Sanitation NGOs/Environmental Agencies
- Industrial Sector

11. Expected Impacts

The deployment of the Jal-IoT system is expected to bring significant improvements in water quality monitoring and delivery service management, especially in rural and remote areas. potential anticipated impacts include,

• **Improved Water Resource Management**

Real-time monitoring of water quality and supply enables authorities to make informed decisions, ensuring efficient water usage and reducing wastage.

• **Enhanced Water Quality Monitoring**

Continuous and automated data collection from sensors provides accurate insights into water quality, helping to detect contamination early and enabling prompt corrective actions.

- **Data-Driven Decision Making**

The availability of real-time, cloud-based data allows for more responsive and data-driven management strategies, leading to better planning and allocation of resources.

- **Cost-Effective Operations**

By automating water monitoring and reducing the need for manual inspections, the Jal-IoT system lowers operational costs and improves the overall efficiency of water service delivery systems.

- **Increased Accountability and Transparency**

The system offers transparency in water distribution and service performance, enabling communities and authorities to track water usage and quality, fostering greater accountability.

- **Empowerment of Rural Communities**

The system's deployment in rural areas empowers communities by providing reliable data on their water services, leading to better local governance and improved public health.

- **Scalability and Adaptability**

The Jal-IoT system is designed to be scalable and adaptable to different regions and water management needs, making it a flexible solution for diverse water monitoring challenges.

- **Sustainability and Environmental Impact**

By optimizing water resource usage and reducing water wastage, the system contributes to sustainable water management practices and helps mitigate the environmental impact of water scarcity.



For queries, please write to :

Scientist and Head

Business Development Group CSIR-Central Scientific Instruments Organisation (CSIO), Sector 30-C, Chandigarh-160030, India



+91 172 270 3585



head.bdg@csio.res.in



director@csio.res.in



<http://www.csio.res.in>

Dr. Babankumar S. Bansod

scientist_babankumar@csio.res.in



**GIS-BASED DASHBOARD FOR AFFORDABLE
IOT-ENABLED WATER SERVICE DELIVERY
MEASUREMENT AND MONITORING
(IOT DASHBOARD 1.0)**

TRL 5

CSIR- National Environmental Engineering Research Institute
(CSIR-NEERI), Nagpur - 440020, Maharashtra, India

1. **Name of CSIR Laboratory**
**CSIR-National Environmental Engineering Research Institute (CSIR-NEERI),
 Nagpur - 440 020, Maharashtra, India.**
2. **Name of Technology**
 GIS-Based Dashboard for Affordable IoT-Enabled Water Service Delivery Measurement and Monitoring (IoT Dashboard 1.0).
3. **TRL Level: 5**
 (Validated functionality in a real-world operational environment)

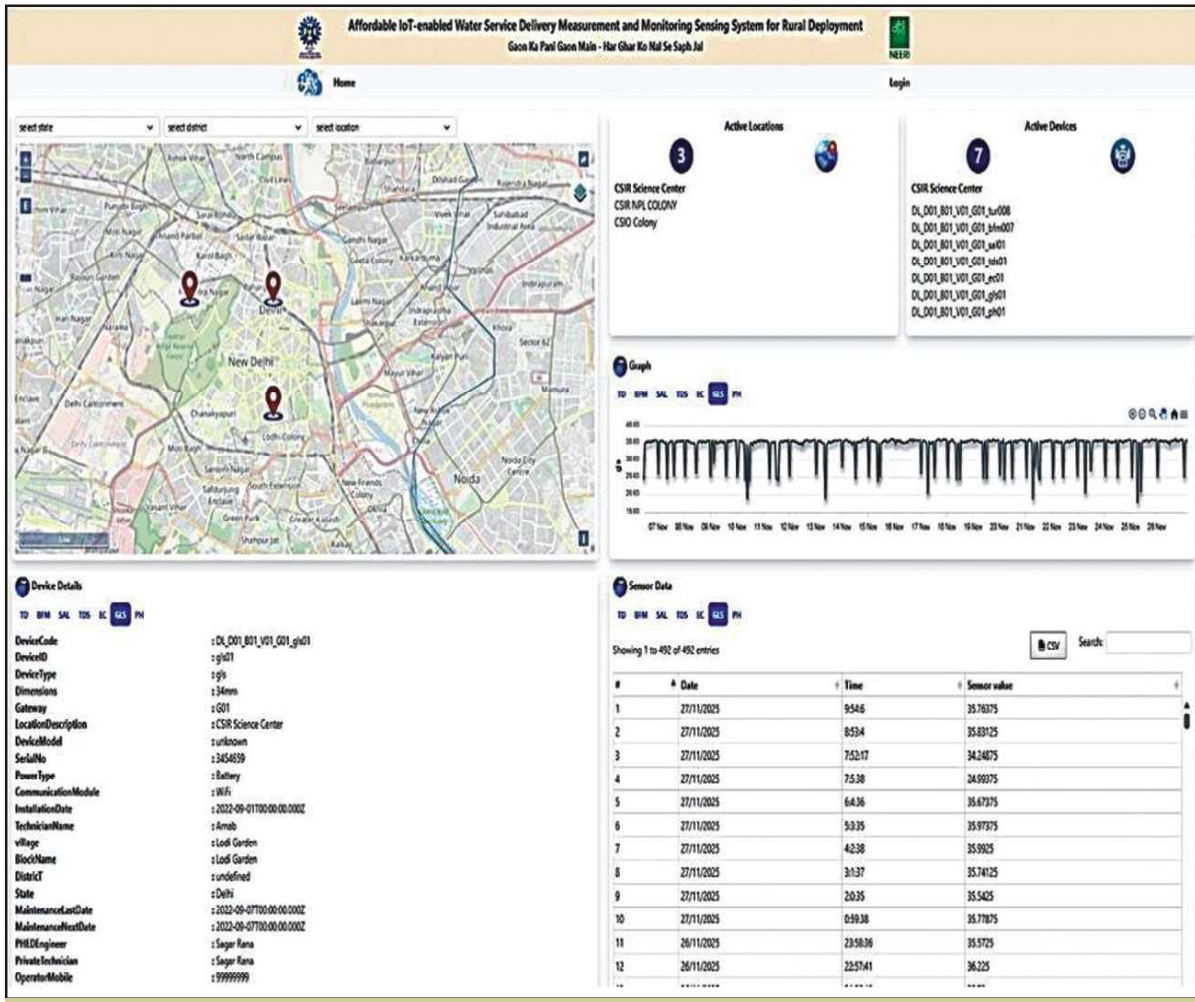

4. Preamble

CSIR-NEERI's GIS-based live water sensor data dashboard is a cutting-edge solution designed to integrate metadata, sensor data, and geospatial insights. It enables real-time water quality monitoring across various administrative levels by combining manual field data with in-situ sensor readings. This technology aligns with the Jal Jeevan Mission (JJM) standards, enabling data-driven water management to ensure safe, sustainable water delivery to rural and urban communities.

5. Technical Description

The system operates on a seamless cloud-integration model, developed in a Docker environment for portable, hassle-free deployment. It functions as an Intelligent Asset Management tool that efficiently stores, updates, and organizes infrastructure data. The dashboard supports OGC-compliant standards, ensuring interoperability with existing water management systems. It utilizes advanced analytics to generate statistical reports, dynamic graphs, and automated alerts for sensor failures or data disruptions. Furthermore, it integrates with decision-support systems like RISK-PiNET to analyse demand-supply gaps and contamination risks.

6. Design Details

- **Platform:** Web-based GIS Dashboard.
- **Architecture:** Microservices architecture (Docker environment).
- **Integration:** Compatible with IoT sensors and Cloud platforms.
- **Data Flow:** Sensor -> Cloud/Server -> Analytics Engine -> Dashboard Visualization (Maps/Graphs).

6.1. Salient Features

- **Dynamic Data Management:** Capability to add, delete, and update sensor data and locations.
- **Real-Time Monitoring:** Display of near-live sensor properties and values.
- **Advanced Analytics:** Generation of statistical analyses, visual reports, and dynamic graphs.
- **Automated Alerts:** Detection of sensor failures and data disruptions.
- **Integration capabilities:** Compatible with RISK-PiNET for gap analysis and contamination risk assessment.
- **Portability:** Developed in a Docker environment for quick installation.

6.2. Equipment and Machinery Required for Deployment:

- **Server/Cloud Storage:** To host the dashboard and database.
- **Computing Devices:** Desktops/Laptops/Smartphones for accessing the dashboard.
- **IoT Sensors:** Field sensors for water quality/quantity measurement.
- **Internet Connectivity:** For data transmission.

6.3. Duration to the First Output after Installation:

Immediate (Real-time data visualization upon sensor connection).

6.4. Is the Product Output Seasonal or Continuous:

Continuous (24/7 Real-time monitoring).

6.5. Quality and Stability of the Obtained Product:

High stability with automated alerts for data disruptions. Validated in real-world environments (Delhi and Chandigarh).

6.6. Market Demand of the Product:

High demand from government agencies, municipalities, water boards, and MSMEs due to the push for smart water management under the Jal Jeevan Mission. It offers a 40-50% cost reduction compared to imported technologies.

6.7. Resource Required (Raw Material, Energy, Water, etc.) for operationalization of the technology:

- **Hardware:** Cloud Server/Local Server.
- **Power:** Electricity for the server and sensors.
- **Data:** Internet connectivity.

6.8. Climatic and Geographical Conditions Required (Temperature, Rainfall, Humidity, Wind, Train, Soil Condition):

The software is location-agnostic. Field sensors require conditions suitable for electronics (protected from extreme physical damage).

6.9. Area Footprint of the Process:

N/A (Software-based). Requires server space.

6.10. Gestation Period of the Project:

Low (Quick deployment via Docker).

6.11. Economic Unit Size:

- Scalable from village-level to city/state-level deployment.

6.12. Indicative Investment:

Cost-effective (approx. 40-50% reduction compared to imported alternatives). Licensing terms available upon request.

6.13. Status of Commercialization of the Technology:

- Ready for commercialization and technology transfer. Demonstrated successfully in Delhi (2 locations) and Chandigarh (1 location). IPR Secured (Copyright Ref. No. SW-20070/2025).



7. Technology photos (Field installations)



For queries, please write to :

Director,

CSIR-National Environmental Engineering Research Institute (CSIR-NEERI),
Nehru Marg, Nagpur-440020, Maharashtra India.



+91-712-2249999



+91-712-2249900



director.neeri@csir.res.in



<http://www.neeri.res.in>
<https://hargharnal.neeri.res.in/ctmd/>



'JALABHILEKH' : A MOBILE APPLICATION FOR IDENTIFICATION, GEOTAGGING, AND WATER BODY CHANGE DETECTION

TRL 4

CSIR- National Environmental Engineering Research Institute
(CSIR-NEERI), Nagpur - 440020, Maharashtra, India

1. **Name of CSIR Laboratory**
CSIR-National Environmental Engineering Research Institute (CSIR-NEERI),
Nagpur - 440 020, Maharashtra, India.
2. **Name of Technology**
'Jalabhilekh': A Mobile Application for Identification, Geotagging, and Water Body Change Detection.
3. **TRL Level: 4**
(Validated performance in relevant environments)

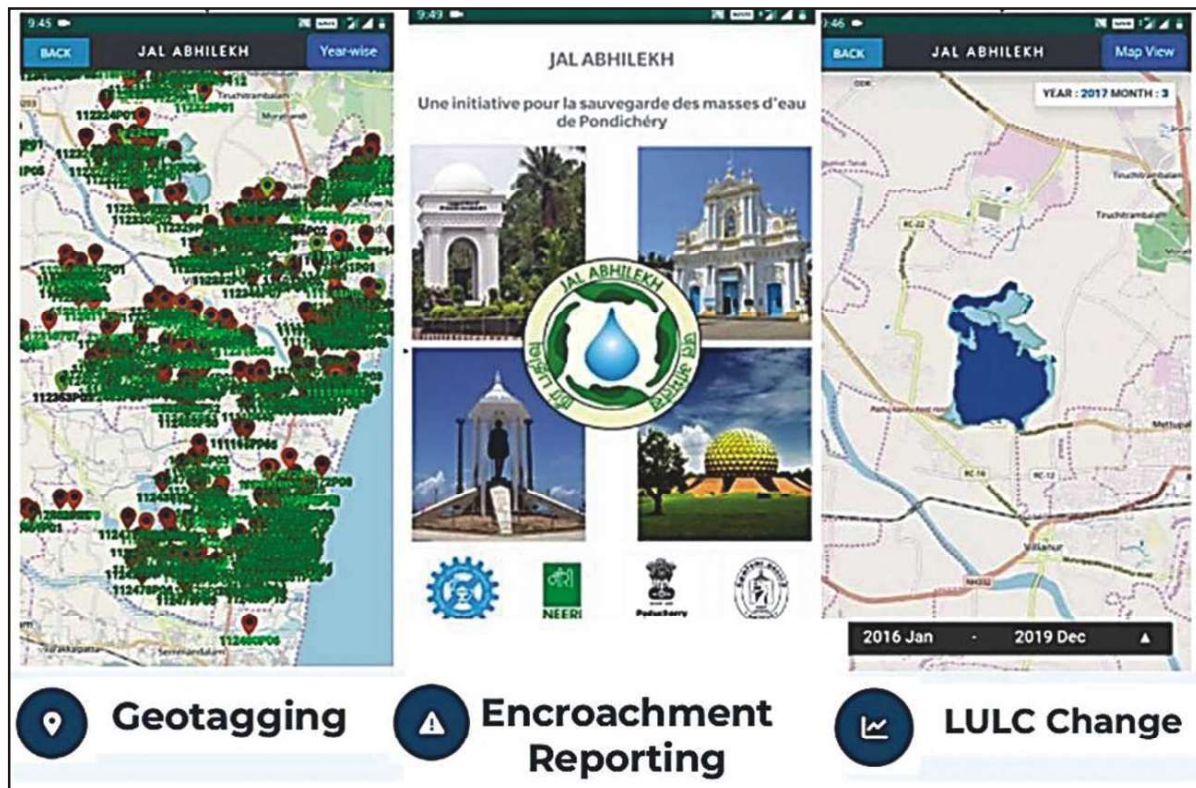

4. Preamble

'Jalabhilekh' is a mobile application designed to safeguard water resources through community engagement and advanced technology. Developed as a proof of concept in Puducherry, the app facilitates the identification, geotagging, and management of water bodies. It empowers local authorities and citizens to participate actively in water conservation, supporting the rejuvenation of water bodies vital to agriculture and community well-being.

5. Technical Description

The application uses a land-use change detection algorithm integrated with Google Earth Engine and Firebase. It combines crowdsourced data collection with automated identification using remote sensing data (Sentinel-1 and Landsat satellites). The system offers near-real-time monitoring of land-use changes and includes a grievance reporting mechanism for issues such as encroachment.

6. Design Details

- **Platform:** Mobile Application (Android).
- **Backend:** Google Earth Engine, Firebase.
- **Data Source:** Satellite Imagery (Sentinel-1, Landsat) and Crowdsourcing.
- **Modules:** Geotagging, Know Your WB (Water Body), LULC (Land Use Land Cover) Change, Tour to WB, Grievance Redressal.

6.1. Salient Features

- **Geotagging:** An Interactive map displaying water body details, Unique ID (UID), status, and locality.
- **Automated Identification:** Achieved 76.8% accuracy in identifying water bodies in Puducherry.
- **LULC Change Detection:** Visualizes land use changes from 2014-2019.
- **Virtual Tours:** "Tour to WB" feature with drone videos.
- **Crowdsourcing:** Enables public and local authorities to upload data.
- **Grievance Reporting:** Allows users to report encroachment or pollution.

6.2. Equipment and Machinery Required for Deployment:

- **User End:** Smartphone with GPS and Internet.
- **Backend:** Server/Cloud infrastructure for data processing.

6.3. Duration to the First Output after Installation:

Immediate (Real-time data upload and retrieval).

6.4. Is the Product Output Seasonal or Continuous:

Continuous.

6.5. Quality and Stability of the Obtained Product:

Successfully identified 700 water bodies and aided in the restoration of 194 bodies in Puducherry.

6.6. Market Demand of the Product:

High potential among Government Agencies, Environmental NGOs, Smart City Developers, and Research Institutions for water conservation and restoration projects.

6.7. Resource Required (Raw Material, Energy, Water, etc.) for the operationalization of the technology:

- **Data:** Satellite imagery feeds.
- **Human Resources:** Community participation for data validation.

6.8. Climatic and Geographical Conditions Required (Temperature, Rainfall, Humidity, Wind, Rain, Soil Condition):

Applicable globally, requires customization for specific regional maps.

6.9. Area Footprint of the Process:

N/A (Mobile Application).

6.10. Gestation Period of the Project:

Immediate deployment upon regional customization.

6.11. Economic Unit Size:

- Scalable from district to state level.

6.12. Indicative Investment:

Requires customization costs for large-scale implementation.

6.13. Status of Commercialization of the Technology:

- Copyright registered in India (Reg No: SW-13979/2020). Successfully demonstrated in Puducherry. Ready for customization and broader adoption.

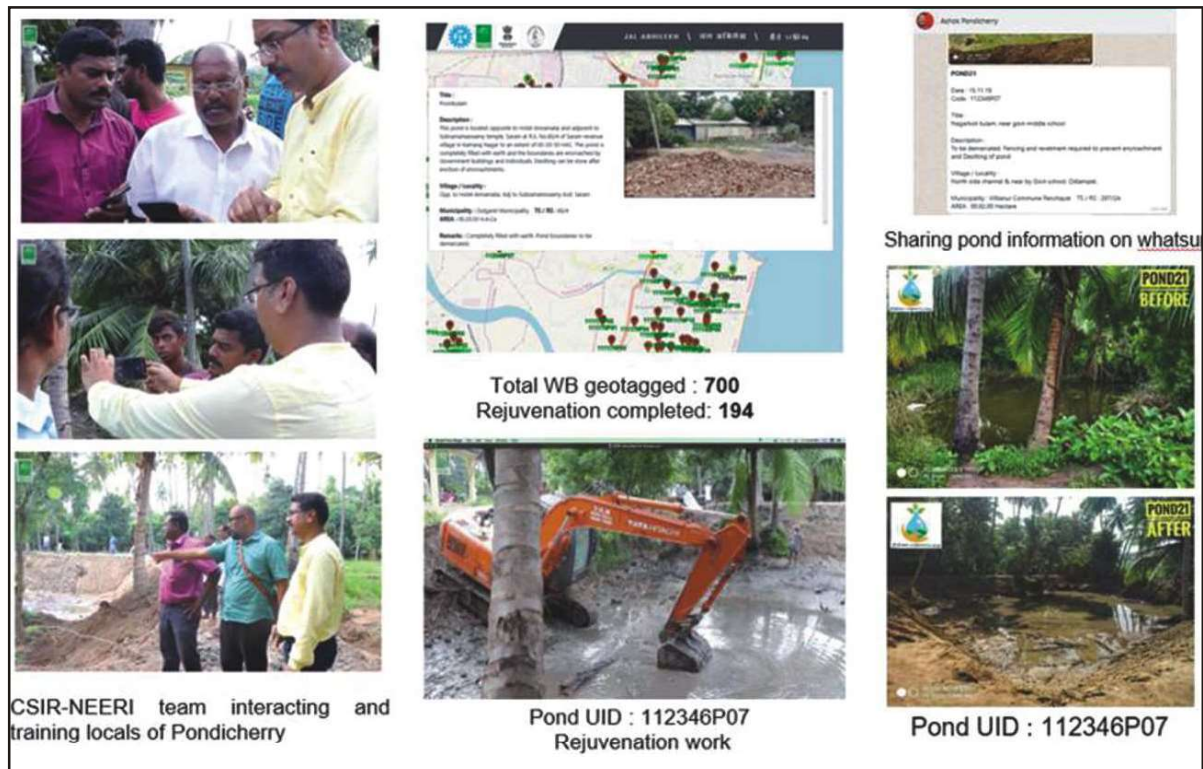
7. Technology photos (Field installations)

For queries, please write to :

Director,

CSIR-National Environmental Engineering Research Institute (CSIR-NEERI),
Nehru Marg, Nagpur-440020, Maharashtra India.



+91-712-2249999



+91-712-2249900



director.neeri@csir.res.in



<http://www.neeri.res.in>
<https://hargharnal.neeri.res.in/ctmd/>



PIPESELECT 1.0 : A TOOL FOR SELECTION OF PIPE MATERIAL FOR WATER SUPPLY AND SEWERAGE SYSTEMS

TRL 4

CSIR- National Environmental Engineering Research Institute
(CSIR-NEERI), Nagpur - 440020, Maharashtra, India

1. **Name of CSIR Laboratory**
CSIR-National Environmental Engineering Research Institute (CSIR-NEERI),
Nagpur - 440 020, Maharashtra, India.
2. **Name of Technology**
PipeSelect 1.0: A tool for Selection of Pipe Material for Water Supply and Sewerage Systems.
3. **TRL Level: 4**
(Validated performance in relevant environments)

CSIR-National Environmental Engineering Research Institute (CSIR-NEERI)

MS, PSC and BWSC pipes are used in pumping mains not for water distribution system.

Water Distribution System [Reset WDS]

Form

1. Select materials for analysis
Following pipe materials are available for water distribution system.

Metallic CI DI GI MS

Cementitious AC BWSC PSC RCC

Plastic GRP HDPE oPVC uPVC

[Done] [Confirm] [Clear]

2. Define pipe dimensions and soil
Select internal diameter and working pressure range. Design period for water distribution system is considered as 30 years.

Design Period (years): 30

Length of the pipe (m): 1000

Internal diameter of pipe (mm): 80 1200

Working pressure: kg/cm² 8 64

Velocity [0.8 - 2.5] (m/s): 1.2

Soil type: Clay

Installation Depth [1 - 10] (m): 1

3. Define interest and inflation rates
Rates of inflation and interest are used in computing the capitalization factor (CF) which is used in repair & maintenance cost computations to show the increase in the cost over the time of failure of pipe within design period.

Rate of interest [1 - 12] (%): 7

Rate of inflation [1 - 12] (%): 6.3

Factor to compute RMC as (% of CC): 2

[Default] [Done] [Submit] [Reset]

4. Preamble

Selecting the appropriate pipe material is a complex challenge in water infrastructure planning. PipeSelect 1.0 is a user-friendly, lightweight software developed to streamline this process. It assists engineers, city planners, and students in selecting optimal pipe materials for water distribution and sewerage systems by integrating technical parameters with cost estimation over a 30-year design period.

5. Technical Description

The software incorporates a comprehensive database of over 1,500 pipe types (10+ materials, multiple classes, and diameters). It employs Multi-Criteria Decision-Making (MCDM) to rank pipes based on system objectives, pressure requirements, environmental conditions, and durability. It provides a comparative analysis of Metallic (CI, DI, GI, MS), Cementitious (AC, BWSC, PSC, RCC), and Plastic (GRP, HDPE, oPVC, uPVC) pipes.

6. Design Details

- **Database:** 10+ pipe materials, various classes and diameters.
- **Algorithm:** Multi-Criteria Decision-Making (MCDM).
- **Outputs:** Material recommendation and Design Period Cost Estimation.
- **Inputs:** Design period, length, diameter, working pressure, velocity, soil type, installation depth, interest/inflation rates.

6.1. Salient Features

- **Extensive Database:** Covers 1,500+ pipe types.
- **Cost Estimation:** Calculates costs for a design period (typically 30 years).
- **Material Optimization:** Compares materials for cost-effectiveness and durability.
- **Pressure Management:** Ensures selected pipes meet specific pressure requirements.
- **Educational Value:** Acts as a reference tool for capacity building.

6.2. Equipment and Machinery Required for Deployment:

- **Hardware:** Standard Computer/Laptop.

6.3. Duration to the First Output after Installation:

Immediate.

6.4. Is the Product Output Seasonal or Continuous:

Continuous (Design tool).

6.5. Quality and Stability of the Obtained Product:

Valid for academic and informational planning purposes.

6.6. Market Demand of the Product:

Useful for Urban Water Infrastructure Planning, Rural Water Supply Projects, and Academic/Research Institutions.

6.7. Resource Required (Raw Material, Energy, Water etc.) for Operationalization of the Technology:

- **Data:** Project specific requirements (pressure, length, soil type).

6.8. Climatic and Geographical Conditions Required (Temperature, Rainfall, Humidity, Wind, Train, Soil Condition):

N/A (Software-based).

6.9. Area Footprint of the Process:

N/A (Software-based).

6.10. Gestation Period of the Project:

Immediate availability.

6.11. Economic Unit Size:

- N/A (Design tool).

6.12. Indicative Investment:

Low cost/Academic pricing (Subject to terms).

6.13. Status of Commercialization of the Technology:

- Available for academic and informational purposes. Secured copyright protection (Copyright no: **SW-20401/2025**). Disclaimer: The tool is a reference guide and does not replace professional due diligence for field implementation.

7. Technology photos (Field installations)

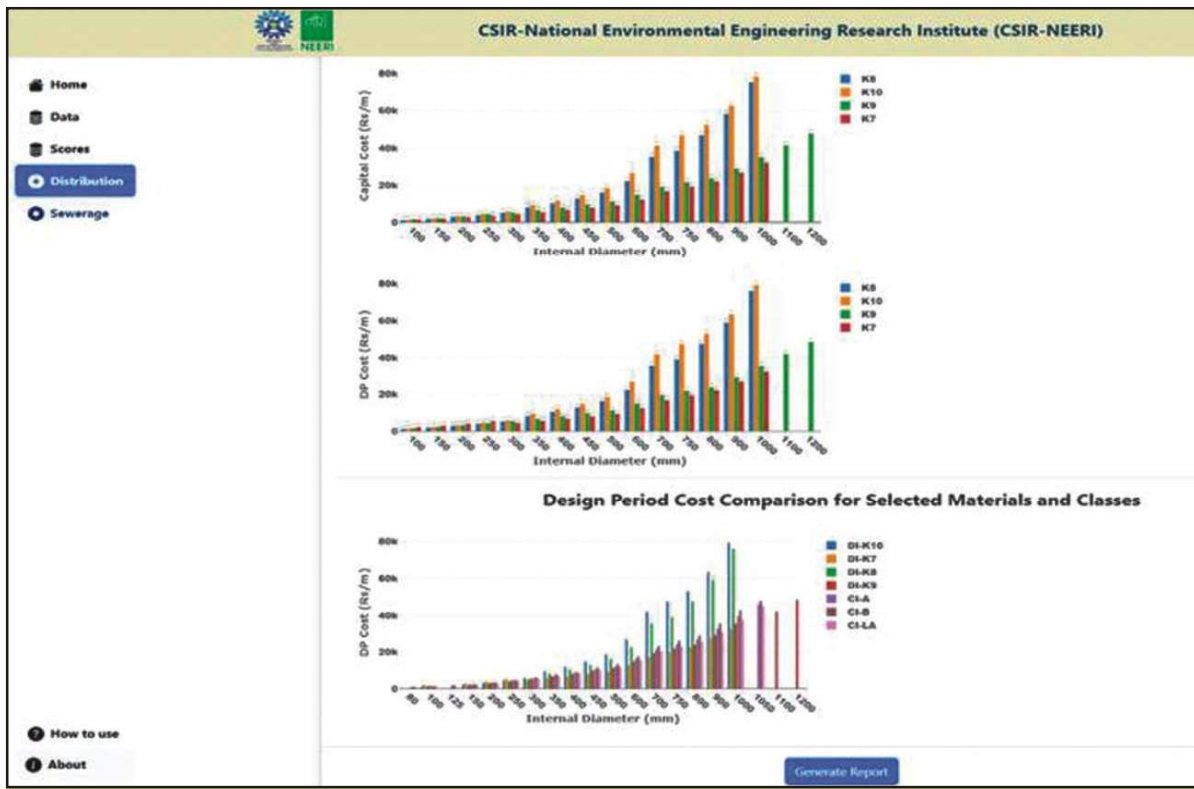

For queries, please write to :

Director,

CSIR-National Environmental Engineering Research Institute (CSIR-NEERI),
Nehru Marg, Nagpur-440020, Maharashtra India.



+91-712-2249999



+91-712-2249900



director.neeri@csir.res.in



<http://www.neeri.res.in>
<https://hargharnal.neeri.res.in/ctmd/>



RISK-PiNET 2.0: SOFTWARE FOR WATER DISTRIBUTION SYSTEM MANAGEMENT

TRL 5

CSIR- National Environmental Engineering Research Institute
(CSIR-NEERI), Nagpur - 440020, Maharashtra, India

1. **Name of CSIR Laboratory**
CSIR-National Environmental Engineering Research Institute (CSIR-NEERI),
Nagpur - 440 020, Maharashtra, India.
2. **Name of Technology**
RISK-PiNET 2.0: Software for Water Distribution System Management.
3. **TRL Level: 5**
(Validated performance in relevant environments)

4. Preamble

RISK-PiNET 2.0 is a transformative Decision Support System (DSS) designed to shift water infrastructure management from reactive maintenance to predictive planning. It is a GIS-based platform that assists Municipal Corporations and Water Boards in identifying critical pipelines prone to failure and contamination, thereby ensuring safe and uninterrupted drinking water supply.

5. Technical Description

The software combines hydraulic analysis, pipe condition assessment, contamination risk evaluation, and rehabilitation cost estimation into a single platform. It utilizes comprehensive analytics to identify vulnerable pipes and supports consultants in preparing Detailed Project Reports (DPR). It integrates Power BI for interactive, real-time data visualization, enhancing decision-making capabilities for utilities and policymakers.

6. Design Details

- **Platform:** Windows-based software.
- **Modules:**
 1. Pipe Condition Assessment.
 2. Contamination Risk Assessment.
 3. Pipe Rehabilitation and Replacement Cost Estimation.
- **Reporting:** Integrated Power BI report generation.
- **Architecture:** Modular design where modules are independent of each other.

6.1. Salient Features

- **Comprehensive Analytics:** Integrates hydraulic performance, condition assessment, and risk evaluation.
- **Advanced Risk Intelligence:** Uniquely incorporates contamination risk assessment.
- **Predictive Maintenance:** Facilitates a shift from digging trial pits to predictive failure analysis.
- **Scalability:** Can be implemented in DMAs (1,000 pipes per simulation) and scaled city-wide.
- **Cost Estimation:** Provides estimates for pipe rehabilitation and replacement.

6.2. Equipment and Machinery Required for Deployment:

- **Hardware:** Standard Windows PC/Workstation.
- **Software Prerequisites:** GIS data (ArcGIS/QGIS), AutoCAD, or WaterGEMS data formats.

6.3. Duration to the First Output after Installation:

Dependent on data availability (Immediate analysis once network data is imported).

6.4. Is the Product Output Seasonal or Continuous:

Continuous (Used for ongoing planning and maintenance).

6.5. Quality and Stability of the Obtained Product:

High. Validated in multiple cities (Nagpur, Shimla, Wardha, Hyderabad).

6.6. Market Demand of the Product:

Growing demand from Smart City developers, engineering consultancy firms, and Urban Local Bodies (ULBs) is driven by urbanisation and regulatory mandates for efficient water management.

6.7. Resource Required (Raw Material, Energy, Water, etc.) for operationalization of the technology:

- **Input Data:** Pipe network details, hydraulic data, and historical failure data.
- **Power:** Standard computing power.

6.8. Climatic and Geographical Conditions Required (Temperature, Rainfall, Humidity, Wind, Train, Soil Condition):

N/A (Software-based). Applicable to any geography with a piped water network.

6.9. Area Footprint of the Process:

N/A (Software-based).

6.10. Gestation Period of the Project:

Immediate deployment upon licensing.

6.11. Economic Unit Size:

- Applicable for individual DMAs up to city-wide networks.

6.12. Indicative Investment:

Details available via commercialization terms (Non-exclusive licensing mode).

6.13. Status of Commercialization of the Technology:

- Ready for commercialization. Deployed in Nagpur, Shimla, Wardha, and Hyderabad. Copyright registered (Ref. No: SW-13985/2020).

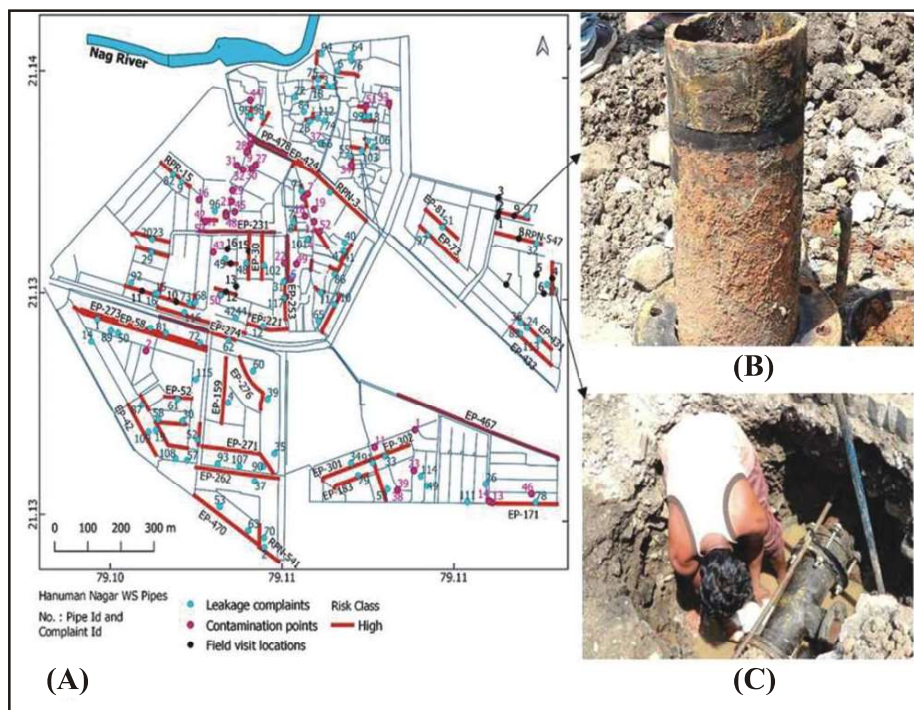
7. Technology photos (Field installations)

For queries, please write to :

Director,

CSIR-National Environmental Engineering Research Institute (CSIR-NEERI),
Nehru Marg, Nagpur-440020, Maharashtra India.



+91-712-2249999



+91-712-2249900







director.neeri@csir.res.in



<http://www.neeri.res.in>
<https://hargharnal.neeri.res.in/ctmd/>

Deployed CSIR Technologies for Drinking Water Management

S.No.	Name of Technology	CSIR Lab	QR Code	Page No.
I. Fluoride Removal Technologies				
1.	Nano-adsorbent based user-friendly household filter for the purification of fluoride, arsenic and microbes contaminated water	CSIR-AMPRI		03
2.	Community Level Fluoride Removal Plant	CSIR-CMERI		13
3.	Domestic Fluoride Removal Unit (Domestic Water Filter for Defluoridation)	CSIR-CMERI		16
4.	High Flow Rate Fluoride & Iron Removal Plant	CSIR-CMERI		22
5.	Community/Domestic Level Fluoride, Arsenic & Iron Removal (FAIR) Technology	CSIR-CMERI		26
6.	Solar Assisted Electrolytic Defluoridation (EDF) Technology	CSIR-NEERI		33
7.	Chemo-Defluoridation Process Unit	CSIR-NEERI		39
8.	Defluoridation – Nalgonda Technique	CSIR-NEERI		43
9.	In-situ treatment of fluoride in a hard rock setting by Managed Aquifer Recharge	CSIR-NEERI		49
II. Arsenic Removal Technologies				
10.	Ceramic Membrane based technology for removal of arsenic (including the process for media preparation) and iron from groundwater	CSIR-CGCRI		55

S.No.	Name of Technology	CSIR Lab	QR Code	Page No.
11.	Ceramic membrane based high capacity modules for: (A) pretreatment of turbid water for polishing of iron & arsenic contaminated water using micro filtration technique and (B) pretreatment of river water for turbidity and suspended particulate removal	CSIR-CGCRI		60
12.	High Flow Rate Arsenic Removal Filter	CSIR-CMERI		64
13.	Community level Arsenic Removal Plant (Model-I)	CSIR-CMERI		69
14.	Community Level Arsenic Removal Filter (Model II)	CSIR-CMERI		73
15.	Process based on polymer-based ion-exchange resins for the removal of arsenic from ground water and arsenic detecting kit	CSIR-CSMCRI		77





III. Iron Removal Technologies



16.	High Flow Rate Iron Removal Filter	CSIR-CMERI		85
17.	Domestic Iron Removal Filter	CSIR-CMERI		90
18.	Community Level Improved Iron Removal Plant (IIRP)	CSIR-CMERI		93
19.	Hand Pump Attachable Iron Removal Plant	CSIR-NEERI		97
20.	Household Iron Removal Unit	CSIR-NEERI		102

S.No.	Name of Technology	CSIR Lab	QR Code	Page No.
-------	--------------------	----------	---------	----------









IV. Turbidity / Microbial / Pathogen Removal Technologies				
21.	Flat sheet ultra-filtration (UF) membrane and spiral module making technology for water purification and removal of pathogens	CSIR-CSMCRI		109
22.	Hollow fiber ultra-filtration membranes for water purification and removal of pathogens	CSIR-CSMCRI		112
23.	Hollow fibre domestic water filter of 1 LPM capacity operated under gravity without any electrical energy	CSIR-CSMCRI		115
24.	Atmospheric water generator with Remineralization	CSIR-IICT		118
25.	Oneer™: A novel solution for safe drinking water	CSIR-IICT		122
26.	TERAFIL Water Purification Technology for treatment of Iron & Turbidity from drinking water	CSIR-IMMT		125
27.	“NEERI-ZAR” – Portable Instant Water Filter	CSIR-NEERI		141
28.	Slow Sand Filtration Technology	CSIR-NEERI		148









V. Reverse Osmosis and Desalination Technologies				
29.	Flat sheet thin film composite (TFC) reverse osmosis membrane and spiral module making technology for brackish & seawater desalination including bio-degradation of organic effluent stream generated in the membrane process development	CSIR-CSMCRI		155

S.No.	Name of Technology	CSIR Lab	QR Code	Page No.
30.	Self-powered mobile van for water purification/desalination to provide safe potable water	CSIR-CSMCRI		173
31.	Compact and affordable hand pump ultrafiltration systems for surface & flood water purification	CSIR-IICT		176
32.	Compact and low-cost modular RO/NF systems for defluoridation of ground water and purification of surface water	CSIR-IICT		180
33.	Ultrafiltration driven Reverse Osmosis system for Mineral Enriched Drinking Water	CSIR-IICT		184

VI. Water Quality Testing Kit				
34.	Portable Water analysis kit	CSIR-IITR		191
35.	Arsenic Estimation Field Kit	CSIR-NEERI		194
36.	Multi-Parameter Water Quality Measurement Field Test Kit	CSIR-NEERI		198

Ready to Deploy CSIR Technologies for Drinking Water Management

S.No.	Name of Technology	CSIR Lab	QR Code	Page No.
I. Fluoride Removal Technologies				
1.	Ceramic Membranes with positive surface charge for defluoridation of contaminated water for drinking purpose	CSIR-CGCRI		10
2.	Fast and safe defluoridation of water using alumina	CSIR-CSMCRI		30
II.				
3.	Preparation of specific polymeric adsorbents for the removal of arsenic and arsenic & fluoride from drinking water	CSIR-CSMCRI		78
IV. Turbidity / Microbial / Pathogen Removal Technologies				
4.	Safe Water and Sustainable Technology Initiative using Indian Knowledgebase (SWASTIIK)	CSIR-NCL		129
V. Reverse Osmosis and Desalination Technologies				
5.	Nano filtration membrane for water softening by partial desalination, decontamination and disinfection	CSIR-CSMCRI		158
6.	Rejuvenation of the end-of-life seawater reverse osmosis membrane elements	CSIR-CSMCRI		161
7.	A high recovery ED-RO hybrid process for water purification/desalination with high water recovery	CSIR-CSMCRI		164
8.	Electro-dialytic desalination for production of mineral-balanced potable water	CSIR-CSMCRI		167
9.	Electro-deionization unit for producing ultrapure water	CSIR-CSMCRI		170

S.No.	Name of Technology	CSIR Lab	QR Code	Page No.
VII.	IoT Enabled Water Service Delivery and Monitoring			
10.	Fluoride Sensing System (FSS)	CSIR-CSIO		205
11.	On-line Nitrate Sensing System (ONSS)	CSIR-CSIO		212
12.	Turbidity Sensing System (TSS)	CSIR-CSIO		218
13.	Jal-IoT	CSIR-CSIO		225
14.	GIS-Based Dashboard for Affordable IoT-Enabled Water Service Delivery Measurement and Monitoring (IoT Dashboard 1.0)	CSIR-NEERI		234
15.	‘Jalabhilekh’: A Mobile Application for Identification, Geotagging, and Water Body Change Detection	CSIR-NEERI		238
16.	PipeSelect 1.0: A tool for Selection of Pipe Material for Water Supply and Sewerage Systems	CSIR-NEERI		242
17.	RISK-PiNET 2.0: Software for Water Distribution System Management	CSIR-NEERI		246



Contact: Director General, CSIR, Rafi Marg, New Delhi India

Tel: +91 11 23710472, 23717053 Fax: +91 11 23710618

Email: dg@csir.res.in; dgcsir@csir.res.in

